

COMPREHENSIVE INSTRUCTION MANUAL

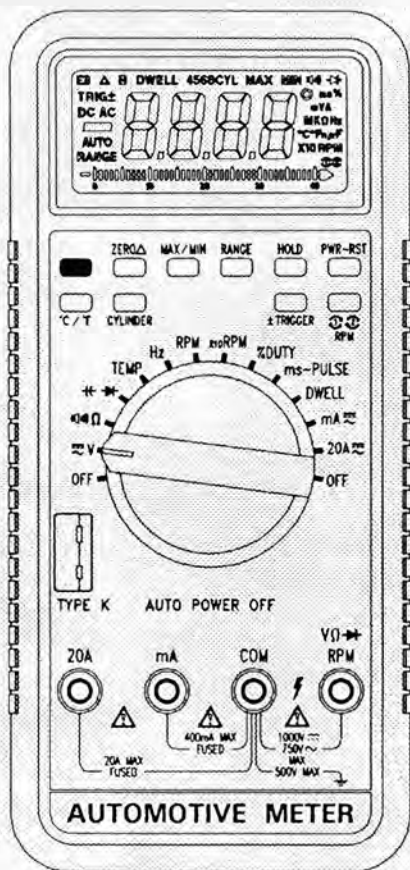

CE

AUTOMOTIVE MULTIMETER

Complete "step-by-step" electrical systems
troubleshooting guide included.

About This Manual

Chapter	Description
Introduction	<ul style="list-style-type: none">• Table of Contents• Safety Warnings
Getting Started	<ul style="list-style-type: none">• Meter Basics• Meter Functions• Maintenance
Basic Diagnostic Testing	<ul style="list-style-type: none">• Battery Testing• Voltage Drop Testing• Starter Motor Testing• Charging System Testing• Ignition System Testing
Basic Component Testing	<ul style="list-style-type: none">• Computer Controlled Systems• Component Tests (Input)• Component Tests (Output)
Specifications	<ul style="list-style-type: none">• General Specifications• Electrical Specifications

DISCLAIMER:

- This manual tells you how to use the meter to perform diagnostic tests and to find possible locations of vehicle problems. It does **NOT** tell you how to correct the problems.
 - All information, illustrations, and specifications contained in this technical manual are based on the latest information available at the time of publication. The right is reserved to make changes at any time without notice.
-

Contents

Introduction	1
Safety	2
Getting Started	5
Meter Basics	6
Digital and Analog display	8
Function and Range Select	9
Push-button Functions	10
Alternate Function	10
Zero Δ	10
Data Record (MAX/MIN)	11
Range Select	11
Data Hold (Hold)	12
Power Reset (PWR RST)	12
Temperature ($^{\circ}$ C/ $^{\circ}$ F)	12
Cylinder	13
\pm Trigger	13
RPM1 and RPM2	13
Meter Functions	14
Voltage	14
Resistance	15
Audible Continuity	16
Diode Check	17
Capacitance	18
Temperature	19
Frequency	20
RPM / x10RPM	21
Duty Cycle	22
ms Pulse	23
Dwell	24
AC or DC Current	25
Maintenance	26
Fuse and Battery Replacement	26
Trouble Shooting	27
Basic Diagnostic Testing	28
Electrical System Diagnostics	29
Battery Testing	30
[1] Battery Test (Surface Discharge)	30
[2] Static Battery Test (No Load)	31
[3] Battery Test (Parasitic Load)	32
[4] Battery Test (Load)	33

Contents Cont'd...

Basic Diagnostic Testing Cont'd	34
Voltage Drop Testing	34
[1] Negative (-) Engine Ground	35
[2] Negative (-) Chassis Ground	36
[3] Battery Power to Starter Solenoid (+)	37
[4] Battery Power to Complete Starter Circuit (+)	38
Starter Motor Testing	39
[1] Starter - Current	39
Charging System Tests	40
[1] Battery (+)	40
[2] Alternator Voltage Output (+), Loaded	41
[3] Alternator Amperage (A) Output, Battery	42
Ignition System Tests	43
[1] Ignition Coil, Primary Resistance Test (Ω)	43
[2] Ignition Coil, Secondary Resistance Test (Ω)	44
[3] Secondary Ignition Wire Resistance Test (Ω)	45
[4] Distributor Cap/Rotor Resistance Test (Ω)	46
[5] Pick-up Coil Resistance/Voltage Test (Ω)	47
[6] Hall Effect Sensor Voltage Test (V)	48
Basic Component Testing	49
Computer Controlled Systems	50
Basic Diagnostics for the Computer Controlled Engine	51
Self-Diagnostic Computer Systems	52
Component Testing	53
Duty Cycle, What is it?	54
Frequency (Hz), What is it?	54
Pulse Width, What is it?	55
Component Tests (Input)	56
[1] Temperature Tests	56
[2] Thermistor (Variable Resistance, 2-wire)	57
[3] Potentiometers (Variable Resistance, 3-wire)	60
[4] Oxygen Sensor (O ₂) Test	63
[5] Pressure Sensor Tests	64
Component Tests (Output)	65
Output Devices	65
Specifications	66
General Specifications	66
Electrical Specifications	67

This chapter covers brief introductory information and safety precautions

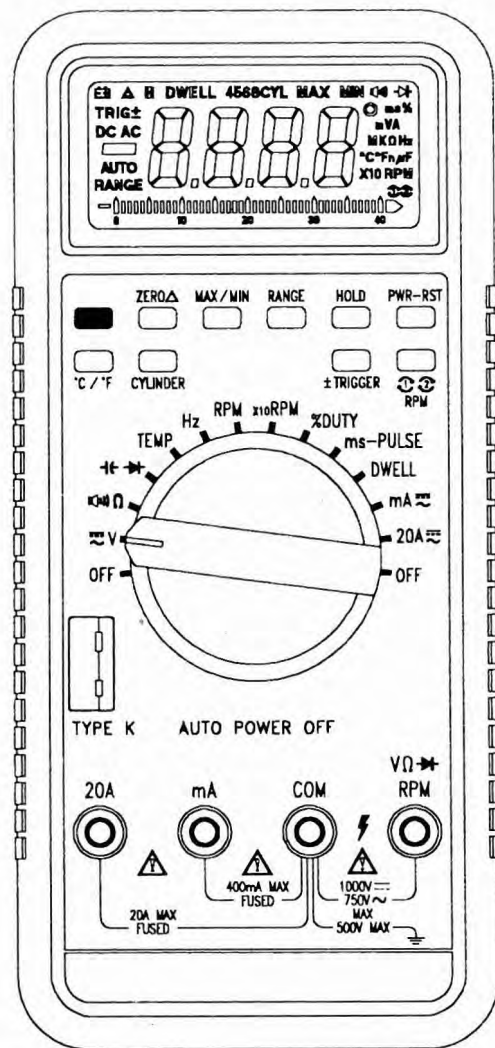

Safety

⚠ DANGER

- Engines produce carbon monoxide which is odorless, causes slower reaction time, and can lead to serious injury. When the engine is operating, keep service areas WELL VENTILATED or attach the vehicle exhaust system to the shop exhaust removal system.



- Set the parking brake and block the wheels before testing or repairing the vehicle. It is especially important to block the wheels on front-wheel drive vehicles: The parking brake does not hold the drive wheels.



- Wear an eye shield when testing or repairing vehicles.



Exceeding the limits of this meter is dangerous. It will expose you to serious or possibly fatal injury. Carefully read and understand the cautions and the specification limits of this meter.

- Voltage between any terminal and ground must not exceed 1000V DC or 750V AC.
- Use caution when measuring voltage above 25VAC or DC.



- Circuit tested must be protected by a 20A fuse or circuit breaker.
- Do not use the meter if it has been damaged.
- Do not use the test leads if the insulation is damaged or if metal is exposed.
- Use current clamps to measure circuits exceeding 10A.

Introduction

Safety Cont'd...

⚠ Danger

- Avoid electrical shock: Do not touch the test leads, tips or the circuit being tested.
- Do not try a voltage measurement with the test leads in the 20A or the mA terminal.
- When testing for the presence of voltage or current, make sure the meter is functioning correctly. Take a reading of a known voltage or current before accepting a zero reading.
- Choose the proper range and function for the measurement. Do not try voltage or current measurements that may exceed the ratings marked on the Function/Range switch or terminal.
- When measuring current, connect the meter in series with the load.
- Never connect more than one set of test leads to the meter.
- Disconnect the live test lead before disconnecting the common test lead.
- The mA and the 20A terminals are protected by fuses. To avoid possible injury or damage, use only in circuits limited to 400mA or 10A continuous /20A for 30 seconds.



See also...

- Fuse Replacement

Introduction

Safety Cont'd...

IMPORTANT

- To maintain accuracy of the meter, replace the discharged battery immediately when the battery symbol  appears on the meter display.
- Avoid measuring error from outside interference: keep the meter away from spark plug or coil wires.
- Avoid damaging the meter when testing voltage: Disconnect the test leads from the test points before changing functions.
- Do not exceed the limits shown in the table below:

Function	Terminal	Input limit
AC Volts	V/Ω/RPM	750VAC rms
DC Volts		1000VDC
Frequency	V/Ω/RPM	500V AC/DC
[1] Ohm(resistance)		
Diode		
AC/DC 400mA	mA	400mA AC/DC
AC/DC 20A	20A	*20A AC/DC
RPM	V/Ω/RPM	500V AC/DC
Duty Cycle (%)		
Dwell angle		

- * 10 Amp measurement continuous or 20Amp measurement for 30 seconds maximum.
- [1] Ohms can not be measured if voltage is present, ohms can be measured only in a non-powered circuit. However, the meter is protected to 500 volts.

This chapter will help you get started. It describes the basic functions of the Meter.

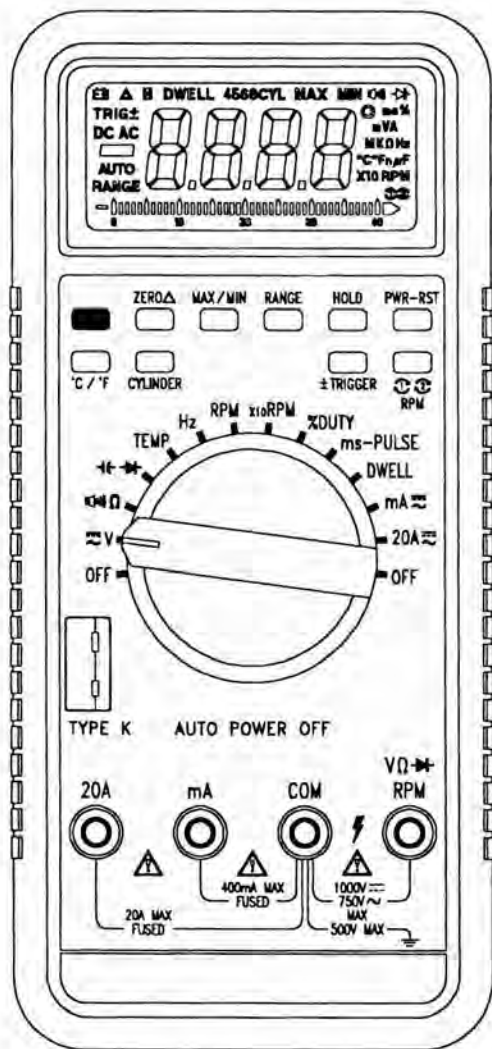

Meter Basics

Meter Boot

The meter boot is designed to protect the meter during accidental falls. Additionally, it provides a convenient method of storage for the meter probes. It also serves as a probe holder that allows the operator to hold the meter and probe in one hand and have the other hand free for operating the remaining test probe.

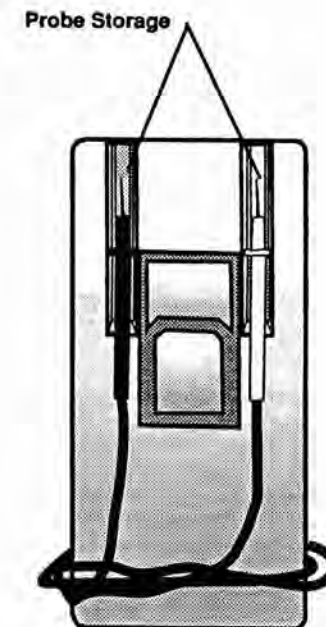

Meter Stand

The meter stand swings out and positions the meter at a convenient viewing angle.

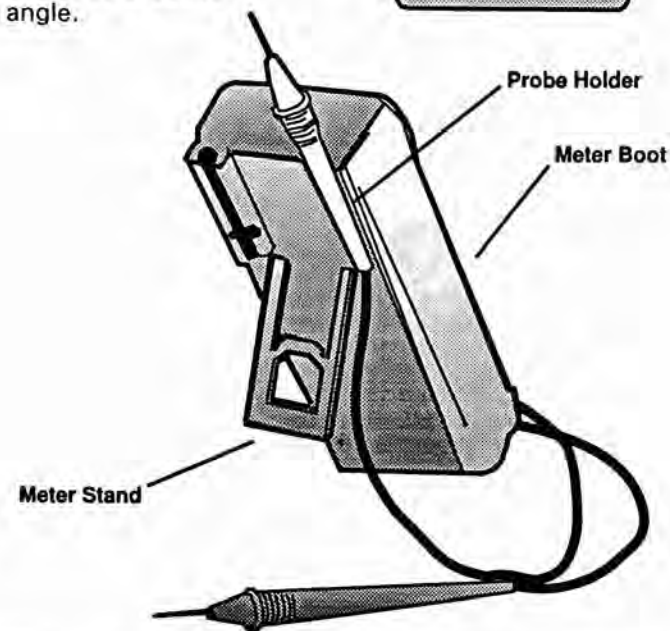

Meter Basics Cont'd...

1. Digital and Analog display

Display features:

- Four character digital display
- Symbols to identify function
- Analog bar graph

The digital display is best for stable input. The bar graph is best for rapidly changing input.

2. Function buttons

Press the button to select a function. A symbol will display to verify your choice.

3. Rotary Selector Switch

Turn this switch to select a function or turn the meter OFF.

4. Temperature Terminal

Insert the temperature probe in this terminal.

5. Test Lead Terminals

The Black test lead is used in the Common (COM) terminal for all tests. The Red test lead is used to measure Amps or Volts.

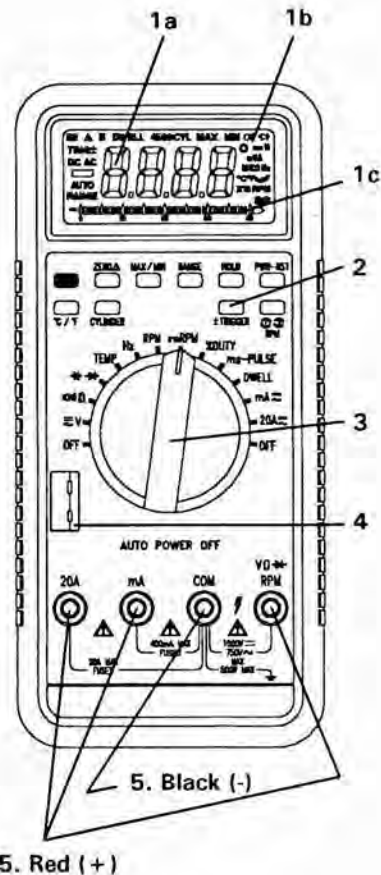

De-activation Features

- **Automatic Power Off** after 30 minutes of no activity.
- **Automatic Power Off Disable** must be set when the meter is to record data over a period of time longer than 30 minutes. To disable the "power off" mode, hold the yellow "PWR RST" button down while switching the meter ON.

Meter Basics Cont'd...

Digital and Analog display

Press **HOLD** to hold data display or resume testing.

Press **MAX/MIN** to read each recording. Minimum or Maximum reading recorded.

Press **ZERO** Δ stores the reading and displays the difference between stored and present reading.

Press **CYLINDER** to select # of cylinders when DWELL is selected with the rotary switch.

Diode or Continuity test

Meter automatically selects best Range

Analog bar Graph display with polarity.

Press $^{\circ}\text{C}/^{\circ}\text{F}$ to alternate Degrees Celsius ($^{\circ}\text{C}$) or degrees Fahrenheit ($^{\circ}\text{F}$).

Press **Alt Function** to select Alternating Current (AC) Direct Current (DC)

Press **TRIG \pm** to select Positive (+) or Negative (-) Trigger Slope

Low Battery
Replace the meter battery when this symbol displays.

Units of measure:
 dwell degrees ($^{\circ}$)
 milli (m = 1/1,000)
 seconds (s)
 percent (%)
 volts (V)
 amps (A)
 mega (M = 1,000,000)
 kilo (k = 1,000)
 ohms (Ω)
 Hertz (Hz)
 nano (n)
 micro (μ)
 farads (F)
 multiplied by 10 (x10)
 Revolutions per minute (RPM)

Meter Basics Cont'd...

Function and Range Select

Turn the rotary switch in either direction to select a function.

The Range is automatically selected by the meter. But, you can also select a range within a function by pressing the range button.

Always select a range higher than you expect the current or voltage to be. Then select a lower range if better accuracy is needed.

- If the range is too high, the readings are less accurate.
- If the range is too low, the meter shows *OL* (over limit).

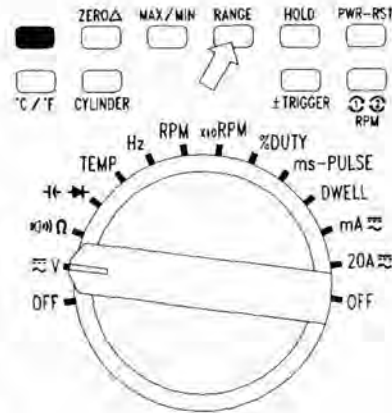

Push-button Functions

Alternate Function

The Alternate Function button is Blue in color. Press it to toggle to the alternate function (AC, audible and capacitance) shown in Blue on the meter face.

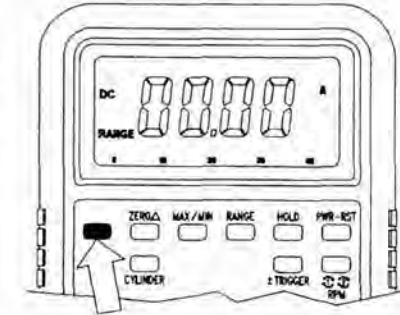

Zero Δ Function

Press the Zero Δ Function button to zero the display and store the reading as a reference value. Press and hold the button for two (2) seconds to exit this mode.

In the Zero Δ mode the value displayed is always the difference between the stored value and the present reading. For example, if the reference value is 24.00V and the present reading is 12.50V, the display will indicate -11.50V. If the new reading is the same as the reference value, the display will be zero.

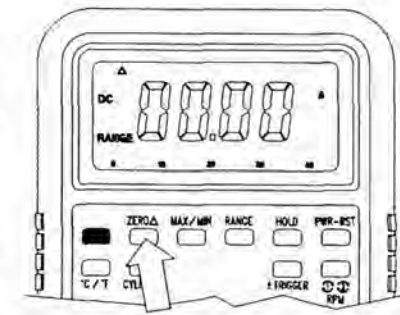

Push-button Functions Cont'd...

Data Record (MAX/MIN)

The Data Record feature stores the highest or lowest reading in memory.

- First, connect the meter probes to the test points. Then, press the **MAX/MIN** button once to start MIN recording. The minimum reading will be displayed.

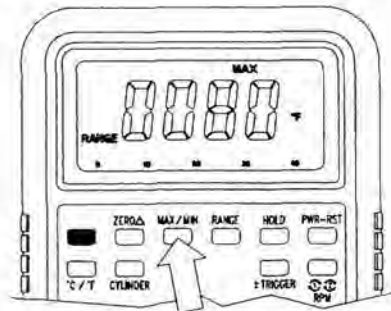

Maximum Reading

- Press the **MAX/MIN** button twice to start the MAX recording. The maximum reading will be displayed.

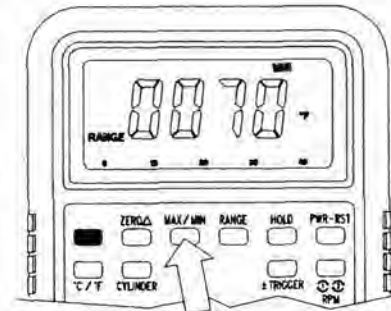

Minimum Reading

- Press the **HOLD** button to stop the recording, press again to restart the recording.

Range Select

The range is automatically selected by the meter. But, you can also manually select a range within a function by pressing the **RANGE** button.

Range Exit

To exit the **RANGE** mode and return to autoranging, press and hold the **RANGE** button for 2 seconds.

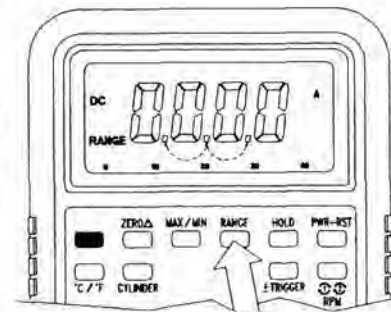

Note:

- If the range is too high, the readings are less accurate.
- If the range is too low, the meter shows OL (over limit).

Push-button Functions Cont'd...

Data Hold

The Data Hold Feature stores the last reading in memory.

- Press the **Data Hold** button once to hold the present reading.
- Press the **Data Hold** button again to exit and resume readings.

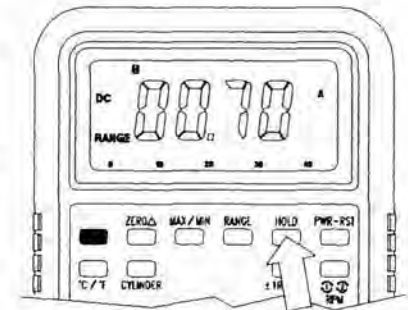

Power Reset (PWR RST)

The PWR RST button turns the meter back on when the meter automatically powers off.

Power Off Disable

To disable the automatic Power Off function, hold down the **PWR RST** button while turning the meter switch from OFF to ON.

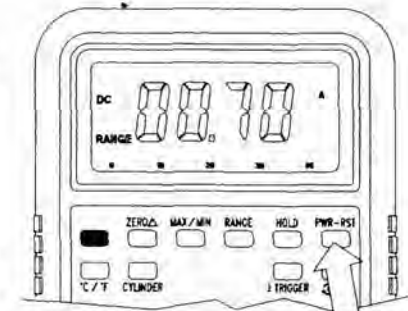

Temperature (°C/°F)

The Temperature feature will display the data in degrees Celsius (°C) or Fahrenheit (°F).

- Press the **°C/°F** button to toggle back or forward to display degrees Celsius (°C) or Fahrenheit (°F).

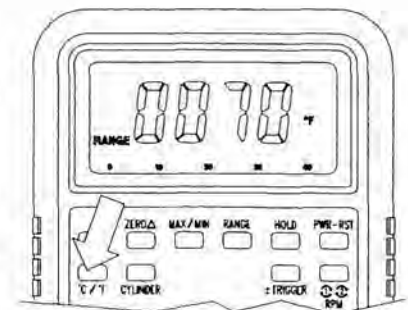

Push-button Functions Cont'd...

Cylinder

Select the Dwell function, press the Cylinder button to toggle between the 4, 5, 6, or 8 cylinder scale.

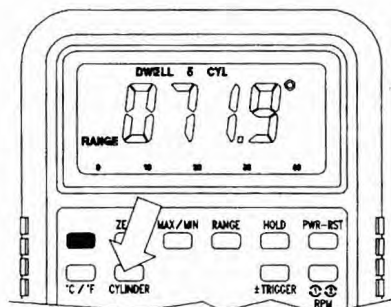

± Trigger

Select the Duty Cycle and Pulse Width function, press the ± Trigger button to toggle between the negative (-) or positive (+) slope.

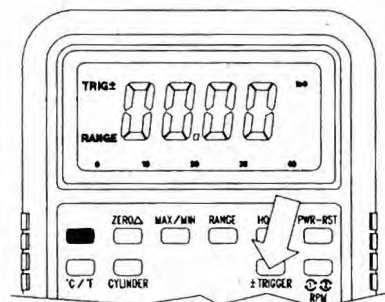

See Also:

Meter Functions

- Duty Cycle
- ms Pulse

Duty Cycle, What is it?

RPM (1) and RPM (2)

In the RPM function the meter defaults to RPM (2) for conventional 4-cycle engines. Press the RPM button to toggle to RPM (1) for 2-cycle engines or waste spark (DIS) 4-cycle engines.

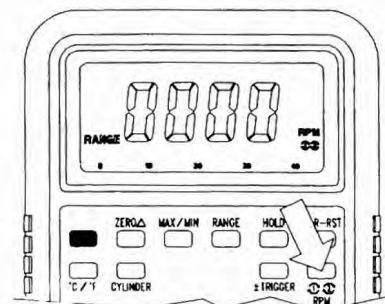

Meter Functions - Voltage (V)

⇒ The meter will automatically select the best voltage (V) range.

⇒ Press the Blue toggle button to select AC or DC.

Insert:

- Black lead in COM terminal.
- Red lead in V/Ω/RPM terminal.

Touch the Black probe to ground or to the negative (-) circuit.

Touch the Red probe to the circuit coming from the power source.

IMPORTANT: voltage must be measured in parallel (Red probe measuring circuit from power source).

⇒ Accuracy

Selection of a lower range will move the decimal point one place and increase the accuracy of the reading. An OL (Over Limit) display means the range is too low, select the next higher range.

⇒ Analog Bar Graph

The Bar graph is easier to read when the data causes the digital display to rapidly change. It is also useful for trend setting or directional data.

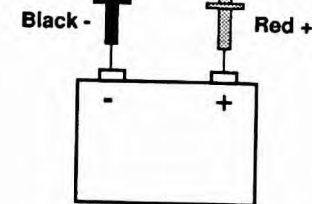
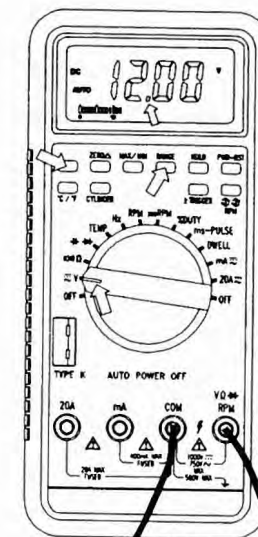

⚠ WARNING

When measuring voltage, be sure the Red test lead is in the terminal marked "V". If the test lead is in an Amp (A) or Milliampere (mA) terminal, you may be injured or the meter damaged.

Getting Started

Meter Functions - Resistance (Ω)

IMPORTANT: If you are testing an application that has capacitors in the circuit, be sure to turn the power OFF on the test circuit and discharge all capacitors. Accurate measurement is not possible if external or residual voltage is present.

⇒ Select the resistance (Ω) setting with the rotary switch.

⇒ Select the resistance (Ω) range with the button labeled "RANGE" if a more accurate measurement is desired.

Insert:

- Black lead in COM terminal.
- Red lead in V/ Ω /RPM terminal.

Note:

The resistance in the test leads can effect accuracy at the 400 Ω range. Short the leads together and press the "ZERO Δ " button to automatically subtract the lead resistance from the resistance measurements.

Touch the test lead probes across the resistor to be tested.

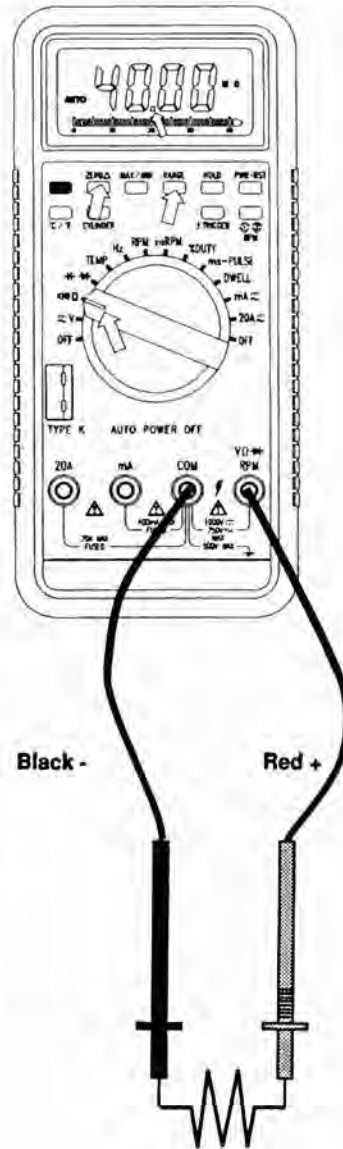

Getting Started

Meter Functions - Audible Continuity (🔊)

IMPORTANT: Turn the power OFF on the test circuit

⇒ Select the Audible Continuity (🔊) range with the rotary switch.

⇒ Press the Blue Alternate Function button to select Audible Continuity.

Insert:

- Black lead in COM terminal.
- Red lead in V/ Ω /RPM terminal.

Connect one test probe to each end of the circuit to be tested.

- Circuit complete, the meter will "beep".
- Circuit open, there is no "beep" and the display shows 400 Ω .

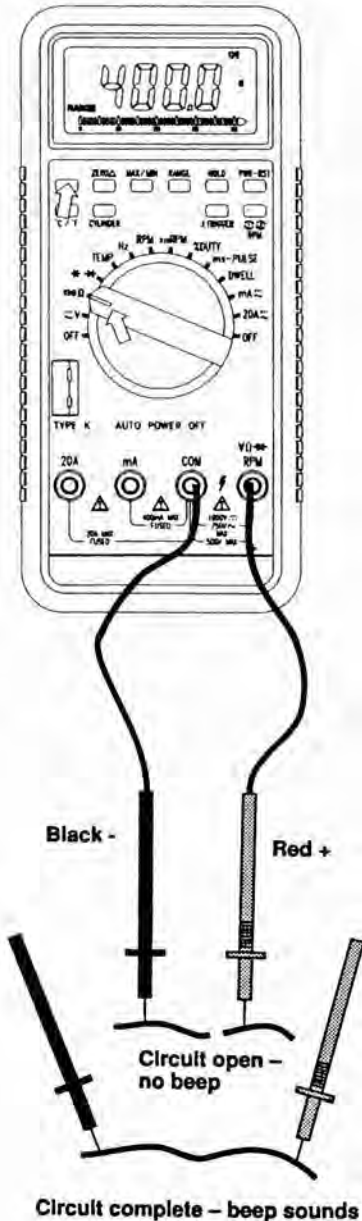

Getting Started

Meter Functions - Diode Check \rightarrow

IMPORTANT: Turn the power OFF to the test circuit

⇒ Select the Diode Check (\rightarrow) setting with the rotary switch.

Insert:

- Black lead in COM terminal.
- Red lead in V/ Ω /RPM terminal.

Touch the Black test probe to the negative (-) side of the diode.

Touch the Red test probe to the positive (+) side of the diode.

Reverse the probes: Black to the positive (+) side and Red to the negative (-) side.

Note:

A "good" diode will read low in one direction and high in the other direction when the probes are reversed (or vice versa).

A defective diode will have the same reading in both directions or read between 1.0 to 3.6 V in both directions.

Diode	Reverse Probes	
	- to +	+ to-
Good	0.4 to 0.9V	3.0 to 3.6V
	3.0 to 3.6V	0.4 to 0.9V
Bad	3.0 to 3.6V	1.0 to 3.0V
	1.0 to 3.0V	3.0 to 3.6V
	0.4 to 0.9V	0.4 to 0.9V
	3.0 to 3.6V	3.0 to 3.6V
	.000V	.000V

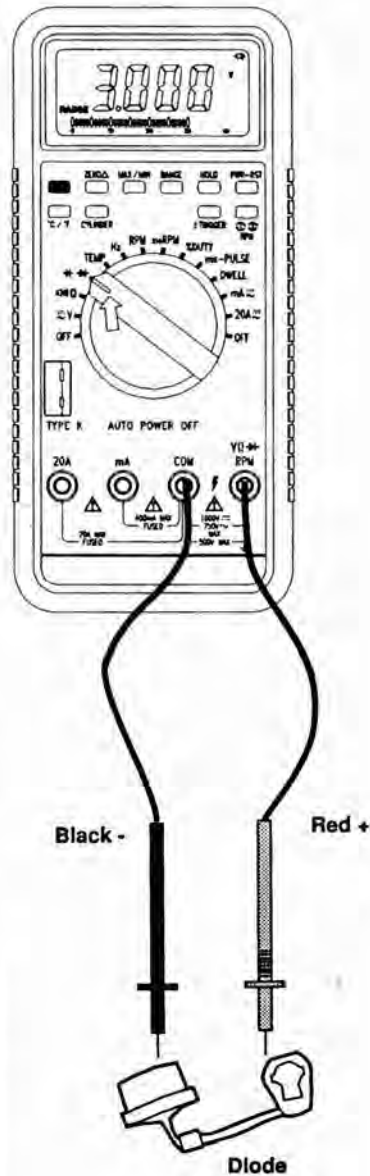

Getting Started

Meter Functions - Capacitance ∇

IMPORTANT: Turn the power OFF to the vehicle circuit to be tested. Discharge the capacitor by shorting the capacitor leads together. Use the DC Volts function to confirm that the capacitor is discharge.

⇒ Select the ∇ range with the rotary switch.

⇒ Press the Alternate Function button to select Capacitance Measurement (∇).

Insert:

- Black lead in COM terminal.
- Red lead in V/ Ω /RPM terminal.

Attach the test probes to the capacitor as illustrated.

Note:

- Holding the probes with your hands may charge the capacitance in circuit and generate a false reading.
- Residual voltage charges on the capacitor, poor insulation resistance or poor dielectric absorption may cause measurement errors.

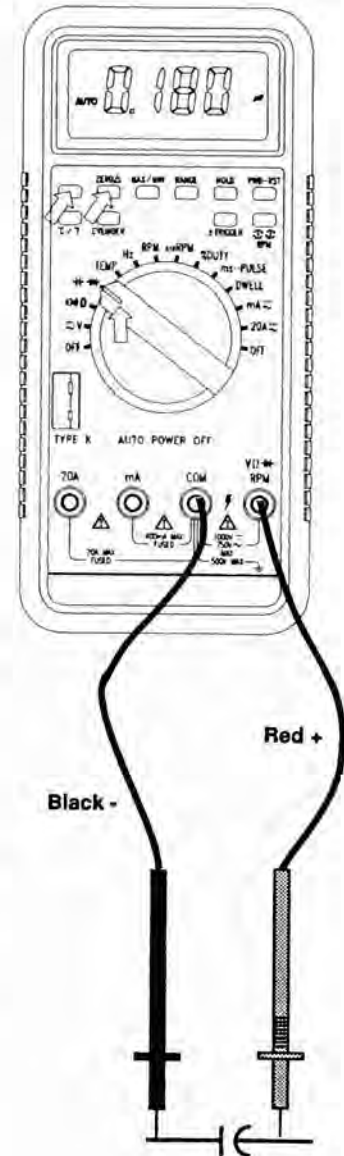

Getting Started

Meter Functions - Temperature (Temp)

IMPORTANT: To avoid heat damage to the meter, keep it away from sources of very high temperature. The life of the temperature probe is also reduced when subjected to very high temperatures (operating range is -50° to $2,000^{\circ}$ F)

⇒ Select the Temperature (Temp) setting with the rotary switch.

⇒ Press the button to select $^{\circ}$ C or $^{\circ}$ F.

⇒ Insert the temperature probe connector into the K-type thermocouple socket.

Touch the end of the temperature sensor to the area or surface of the object to be measured.

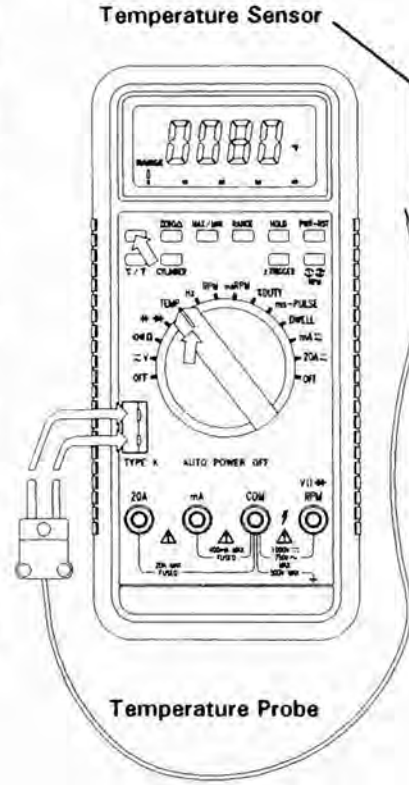

Getting Started

Meter Functions - Frequency (Hz)

⇒ Select the Frequency (Hz) setting with the rotary switch.

Insert:

- Black lead in COM terminal
- Red lead in V/ Ω /RPM terminal.

Connect the Black test probe to ground.

Connect the Red test probe to the "signal out" wire of the sensor to be tested.

Note:

For frequencies below 1 Hz, the display will show 00.00 Hz.

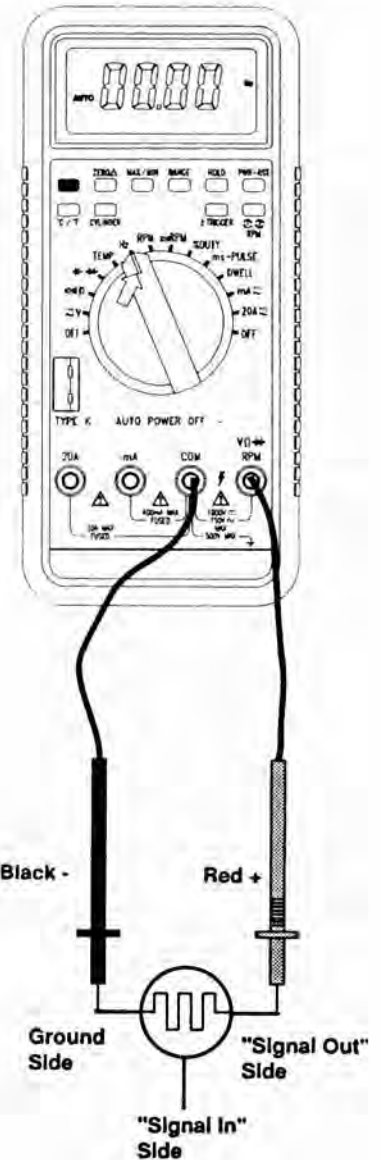

Meter Functions - RPM/X10RPM

⇒ Select the **RPM** range with the rotary switch.

OR

⇒ Select the **X10RPM** range with rotary switch (1,000 to 12,000 RPM). *Multiply the displayed reading times ten to get actual RPM.*

Insert the inductive pick-up connecting terminal into the meter.

- Ground lead in **COM** terminal.
- Output lead in **V/Ω/RPM** terminal.

Connect the inductive pickup to a spark plug wire. If no reading is received, unhook the clamp, turn it over and connect again.

⇒ Press the **RPM** button to toggle between **RPM 1** for 2-Cycle/Distributorless Ignition System (DIS) or **RPM 2** for 4-Cycle engines.

Note:

- *Position the inductive pick-up as far away from the distributor and the exhaust manifold as possible.*
- *Position the inductive pick-up to within six inches of the spark plug or move it to another plug wire if no reading or an erratic reading is received.*

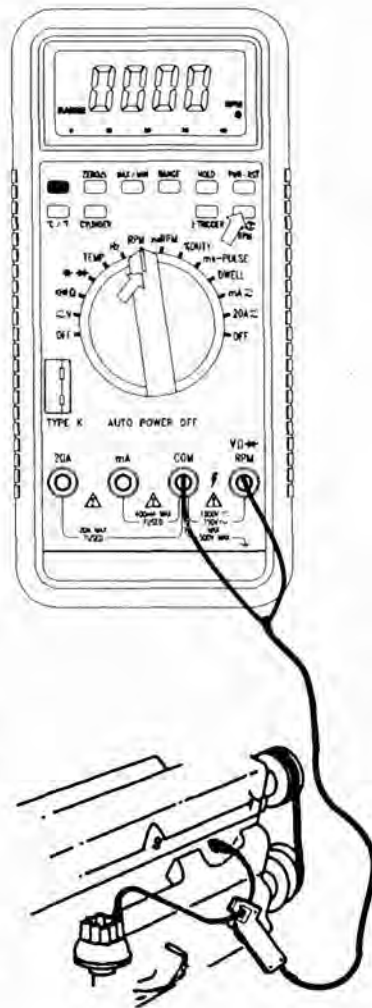

Meter Functions - Duty Cycle (%)

⇒ Select the **% Duty Cycle** range with the rotary switch.

Insert:

- Black lead in **COM** terminal.
- Red lead in **V/Ω/RPM** terminal.

Connect the Black test probe to the ground.

Connect the Red test probe to the signal wire circuit.

⇒ Press the **± TRIGGER** button to toggle between the negative (-) or positive (+) slope.

The illustration for a mixture control solenoid is shown with the metering rod in the closed position.

In most applications, the negative (-) slope is assigned to display the percentage of time the plunger is in the closed position (low duty cycle) during one duty cycle. The positive (+) slope is assigned to display the percentage of time the plunger is in the open position. Refer to the manufacturer's specifications to verify slope assigned to position for each component.

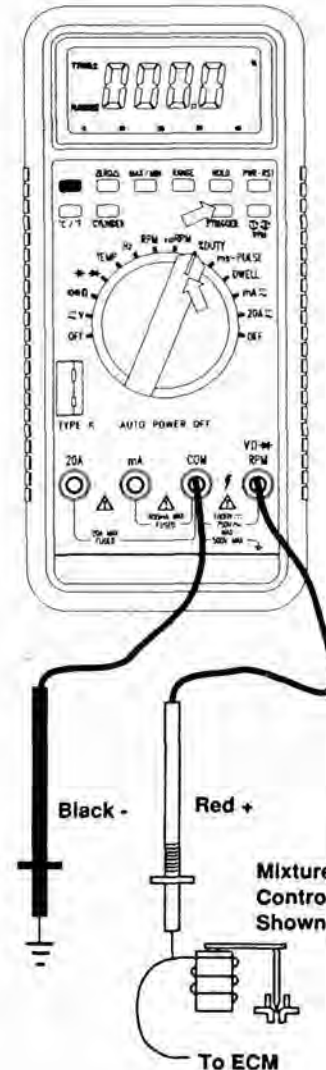

Meter Functions - ms Pulse

⇒ Select the ms Pulse range with the rotary switch.

Insert:

- Black lead in COM terminal.
- Red lead in V/ Ω /RPM terminal.

connect the Black test probe to ground.

Connect the Red test probe to the signal wire that connects to the component to be measured. (see illustration).

⇒ Press the \pm TRIGGER button to toggle between the negative (-) or positive (+) slope.

Note;

The applied time for most fuel injectors is displayed on the negative (-) slope.

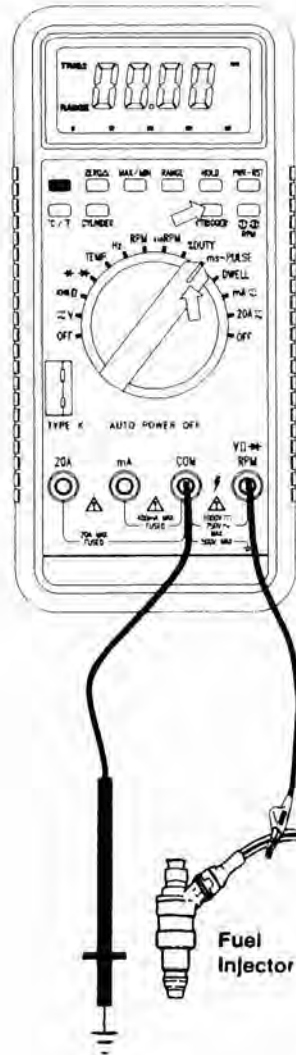

Meter Functions - Dwell

⇒ Select the Dwell range with the rotary switch.

Insert:

- Black lead in COM terminal.
- Red lead in V/ Ω /RPM terminal.

Connect the Black test probe to ground.

Connect the Red test probe to the wire that connects to the breaker points (see illustration).

⇒ Press the CYLINDER button to toggle between 4, 5, 6 or 8 cylinder engines

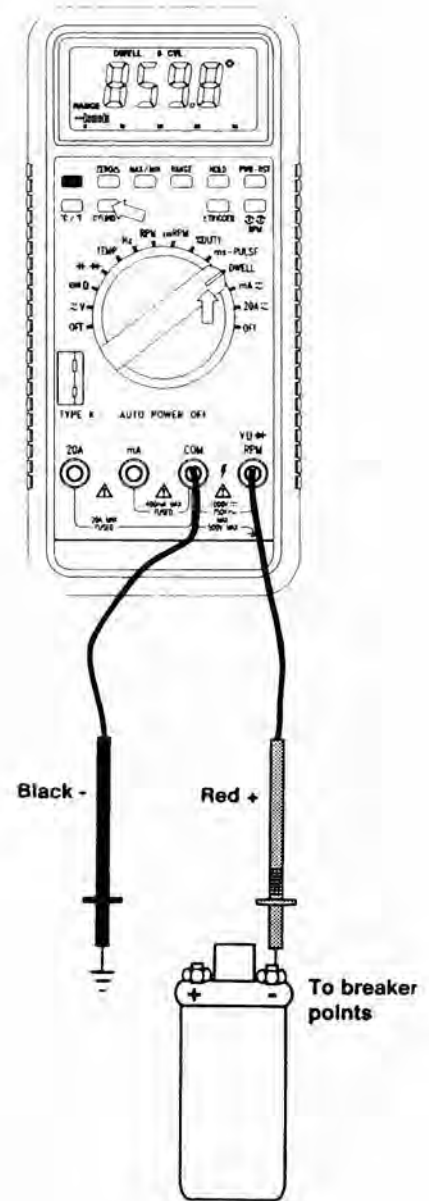

Meter Functions - AC or DC Current (A)

IMPORTANT: All current measured flows through the meter. It is important that you *do not*:

- Measure current greater than 600 Volts AC or DC, with respect to ground.
- Exceed 30 seconds when measuring continuous current between 10A - 20A. Allow five minutes for cool-down before continuing.

⇒ Select the 20A or mA range with the rotary switch.

⇒ Press the Blue Alternate function button to select AC or DC.

Insert:

- Black lead in COM terminal.
- Red lead in the 20A or mA terminal (select 20A if you are unsure of the current draw).

IMPORTANT:

Turn OFF all power to the circuit or disconnect the circuit from the power source.

Connect:

- The Red probe to the side of the circuit closest to the power source.
- The Black probe to the side of the circuit to ground.
- Turn the power ON and test.

Note:
Current must always be measured with the meter test probes connected in series, as described.

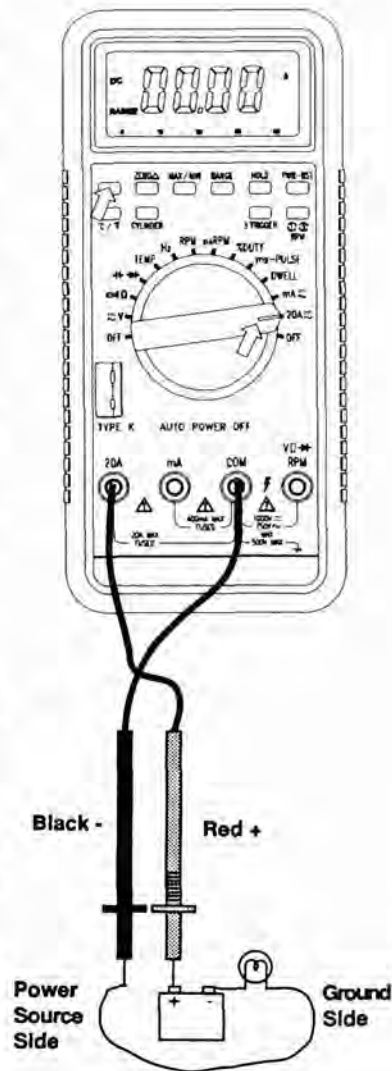

Maintenance

Fuse and Battery Replacement

⚠ WARNING:

- Avoid electrical shock; remove test leads before opening case.
- Do not operate the meter or rotate the meter switch when the case is open.

1. To replace a battery or fuse, loosen the three screws in the case back and remove the case by lifting up and forward.

- Replace the battery with an 9 Volt alkaline battery.

2. To replace a fuse, firmly grasp the printed circuit boards (PC boards) by the edges and lift up and out of the case.

Important:

- To prevent contamination of the circuits, your hands must be clean and the printed circuit board must be held by the edges.
 - Replace the fuses with the same type of fuse.
 - 20A is a F20A, 600V high energy, fast acting fuse.
 - mA is a F500mA, 600V high energy, fast acting fuse.
 - Make sure the replacement fuse is centered in the fuse holder.
3. Carefully re-insert the PC boards into the case. Re-assemble the case, then fasten the three screws.

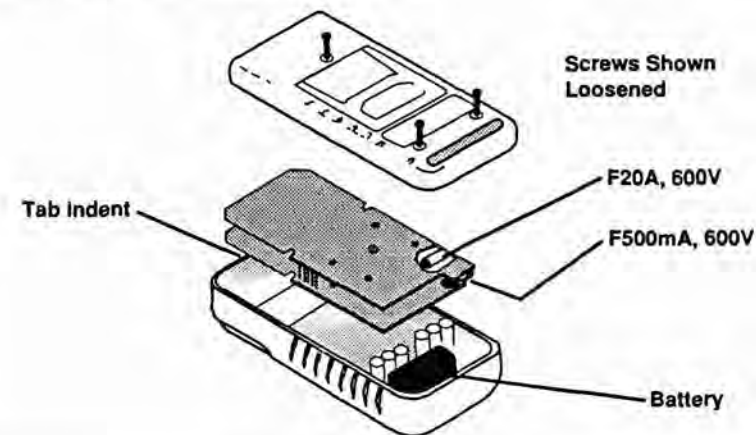

Trouble Shooting

1. Meter will not turn ON.

- Check the battery contacts for a tight fit.
- Check for a minimum battery voltage of 8.0 volts.
- Make sure the battery wires are not pinched in the case

2. Ampere reading is erratic or there is no reading at all.

- Disassemble the meter back cover and test the fuses for continuity.

3. Meter reading is erratic.

- Printed circuit board contaminated from handling with hands
- Low battery.
- Open circuit in a test lead (frayed or broken wire).
- Wrong range selected.
- For frequencies below 1 Hz, the display will show 00.00 Hz
- "Blown" fuse.

4. Meter readings do not change.

- "Hold" feature is still toggled ON

This chapter leads you through a systematic series of tests that check the vehicle electrical system. These tests should be performed before testing individual components.

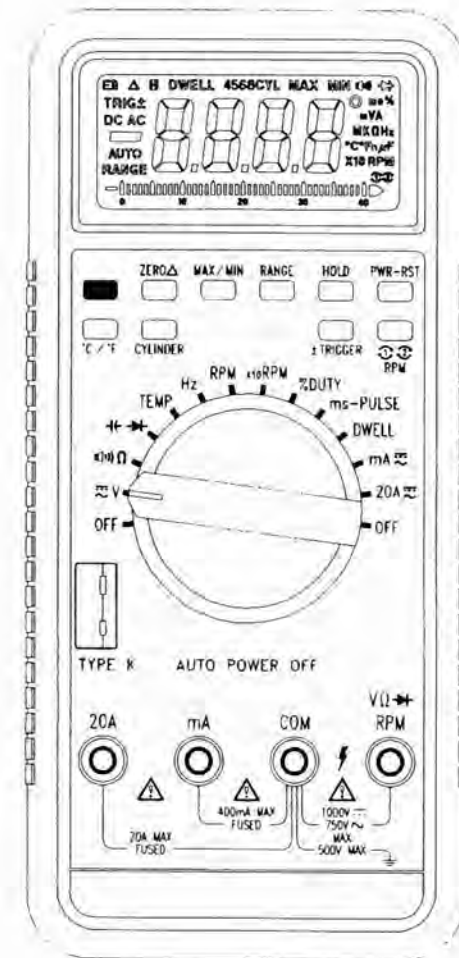

Electrical System Diagnostics

It is important to diagnose a vehicle electrical problem thoroughly and efficiently.

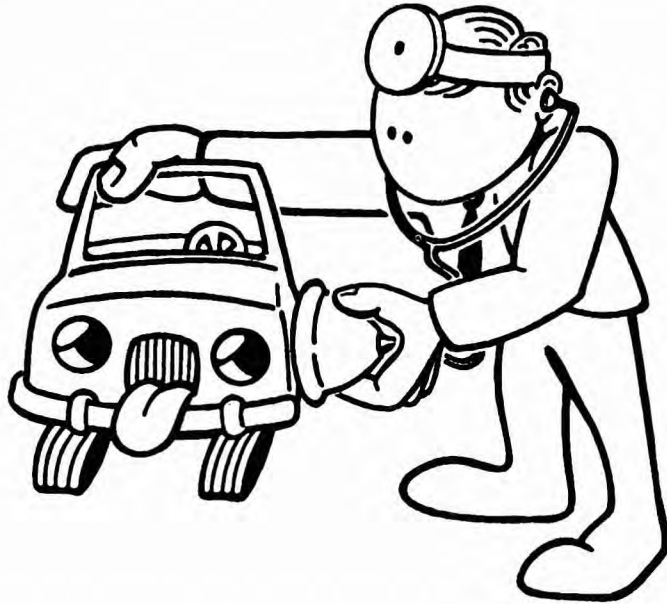

The series of tests that follow check primary areas that are responsible for the majority of the electrical problems found in an automobile. Perform these basic tests first, even if a vehicle has a trouble code set in the computer. A component malfunction detected by the computer can be caused by a basic ground problem in the electrical system. Simply replacing a failed component will not fix the problem if a poor ground caused the component failure.

The tests begin by checking the main source of power and the chassis ground circuit connections. Ground circuits are one of the least understood but potentially most troublesome areas of automotive electronics. An excessive voltage drop in a ground circuit effects the entire electrical circuit. This is why it is important to make sure the basic circuits are in good shape before checking trouble codes and components.

Battery Testing

[1] Battery Test (Surface Discharge)

Note:

- Remove the positive and negative battery cables and thoroughly clean the cable terminals and the battery posts. Reassemble and begin testing.
- The ignition switch must be OFF to prevent damaging the vehicle computer when connecting or disconnecting battery cables.

This test checks for a low current discharge across the battery case.

- Set the rotary switch to Voltage.
- Connect the negative (-) lead to the negative battery post.
- Set the Min/Max feature on the meter.
- Touch the positive (+) lead to the battery case around the positive (+) battery post: Do not touch the post.

A reading of more than 0.5V indicates excessive surface discharge.

Dirt, moisture and corrosion are a cause of surface discharge. Clean the battery with a baking soda and water solution. Do not allow the solution to get into the battery.

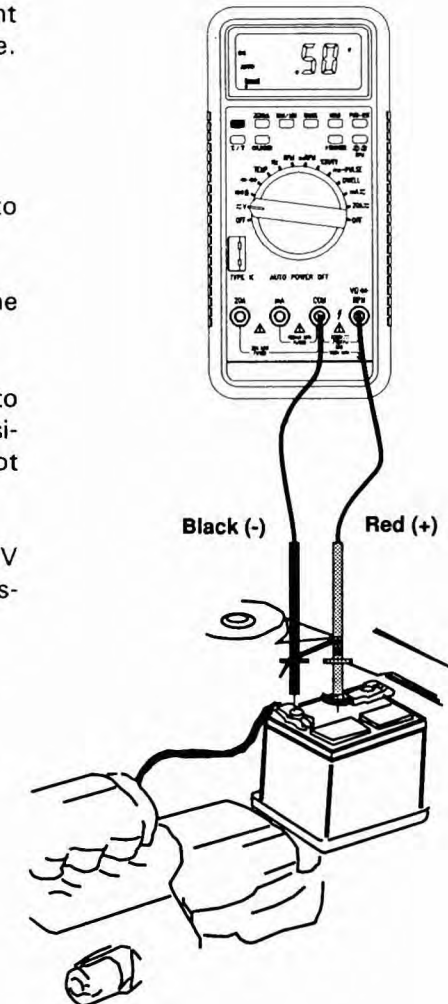

Basic Diagnostic Testing

Battery Testing Cont'd...

[2] Static Battery Test (No Load)

This test checks for battery charge state.

- Turn the headlights on for 15 seconds to dissipate battery surface charge.

IMPORTANT: The ignition switch must be OFF when connecting or disconnecting battery cables to prevent damaging the vehicle computer.

- Disconnect the negative (-) battery terminal.
- Set the rotary switch to Voltage.
- Connect the positive (+) lead to the positive (+) battery post.
- Connect the negative (-) lead to the negative (-) battery post.
- Set the Min/Max feature on the meter.

A reading of less than 12.4V indicates an undercharged battery. Recharge before testing.

NO LOAD TEST

Meter Reading	Battery Charge
12.6V	100%
12.4V	75%
12.2V	50%
12.0V	25%

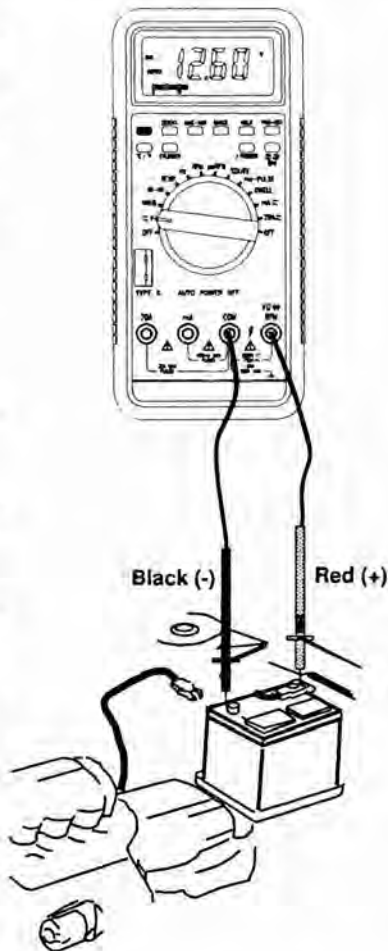

Note:
Leave the battery cable unhooked and proceed to the test on the following page.

Basic Diagnostic Testing

Battery Testing Cont'd...

[3] Battery Test (Parasitic Load)

This tests for excessive parasitic drain on the battery.

- Turn the ignition switch and all accessories OFF.
Important: Do not start the vehicle during this test; meter damage may result.

- Set the rotary switch to 20A.
- Insert the positive (+) lead into the 20A meter terminal.
- Disconnect the battery positive (+) cable.
- Connect the positive (+) lead to the positive (+) battery terminal.
- Connect the negative (-) lead to the disconnected positive (+) battery terminal.
- Set the Min/Max feature on the meter.

Parasitic draw should not exceed 100mA.

If there is excessive draw, remove the circuit fuses, one at a time, until the excessive draw is located. Also check the non-fused applications such as head lights, computer relays and capacitors in the instrument panel.

Reconnect the battery cable for the next test.

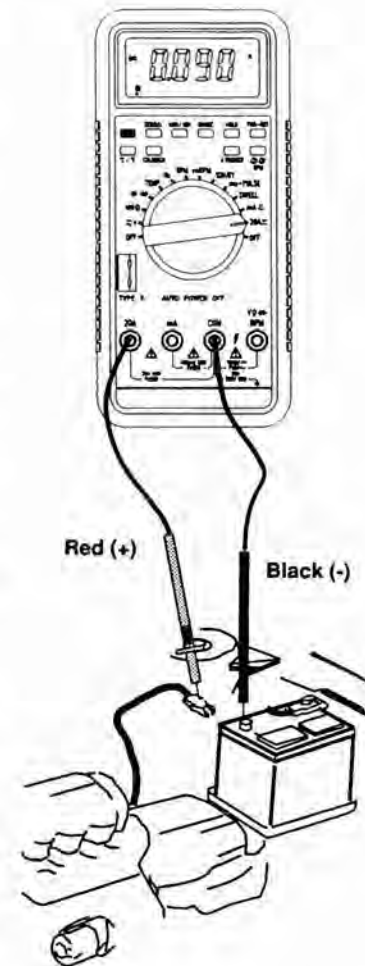

Battery Testing Cont'd...

[4] Battery Test (Load)

This tests the battery's capacity to deliver sufficient cranking voltage.

- Set the rotary switch to Voltage.
- Connect the positive (+) lead to the positive (+) battery terminal.
- Connect the negative (-) lead to the negative (-) battery terminal.
- Set the Min/Max feature on the meter.
- Disable the ignition; crank the engine for 15 seconds.

Check the Min. display. A reading of less than 9.60V@ 70° indicates a weak battery. Recharge/replace before testing.

VOLTAGE LOAD TEST

Meter Reading	Battery/air Temperature
10.0V	90°F/33°C
9.8V	80°F/27°C
9.6V	70°F/21°C
9.4V	60°F/16°C
9.2V	50°F/10°C
9.0V	40°F/4°C
8.8V	30°F/-1°C
8.6V	20°F/-7°C

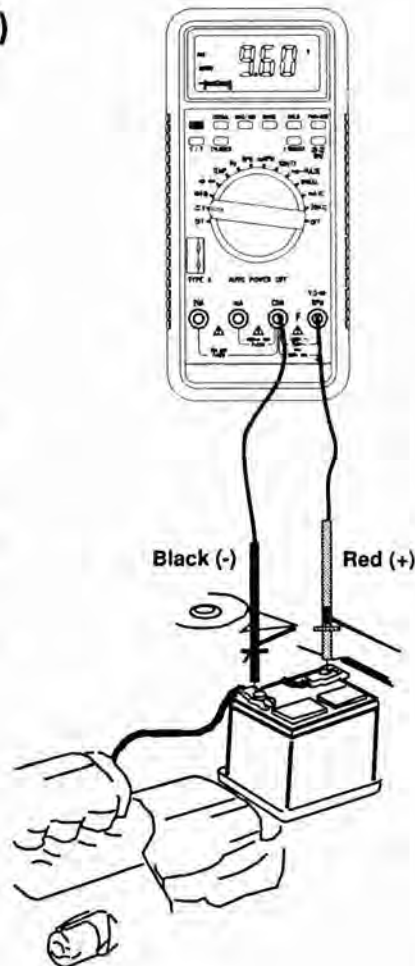

Note:

- For each 10° above or below 70°, add or subtract 0.1 volt.
- Battery temperature can be checked with the meter temperature probe.

Voltage Drop Testing

Resistance, What is it?

Resistance is an opposing force, created by a circuit or component, to the flow of electrical current.

There is a small amount of natural resistance when voltage flows through wires, switches, grounds or connections. The resistance increases beyond acceptable limits if corrosion develops, fittings become loose or wires fray. Resistance increases each time something, such as wire, a switch, connections, or the ground are added in the circuit.

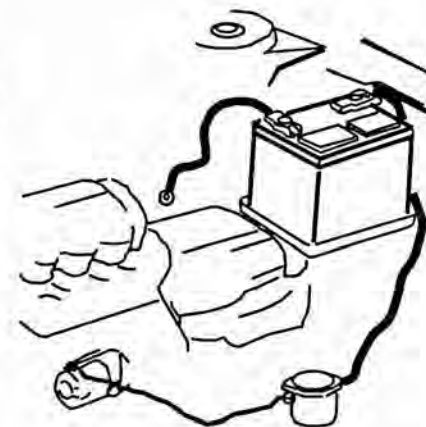

Voltage Drop, What is it?

Voltage drop is the difference in voltage potential when measured across a circuit or component creating resistance.

The resistance decreases the amount of voltage available. The bulb will not light or the motor will not turn if the voltage is too low.

Maximum Voltage Drop

Maximum voltage drop should not be more than 0.1 volt per wire, ground, connection, switch or solenoid.

What Should be Tested?

Each wire, ground, connection, switch, solenoid and the complete circuit should be tested. Each connection point is a potential source of increased resistance.

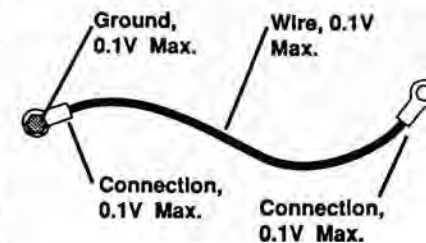

Total resistance should be no more than 0.4V Max. for the example shown.

Voltage Drop Testing

[1] Negative (-) Engine Ground

This test checks for engine ground efficiency.

- Set the rotary switch to Voltage
- Touch the positive (+) lead to the positive (+) battery post and the negative (-) lead to the negative (-) battery post. Note the reading...this will be the base voltage to compare your test voltage reading against.
- Connect the positive (+) lead to a clean spot on the engine block
- Connect the negative (-) lead to the negative battery post.
- Set the Min/Max feature on the meter.
- Disable the ignition so the engine doesn't start; crank the engine for 2-3 seconds.

The example shown has 2 connectors, 1 wire, 1 ground and 1 terminal to battery post. A voltage drop of more than 0.5 volts would indicate a poor ground circuit.

Clean and inspect the battery cable connections and the ground; test again.

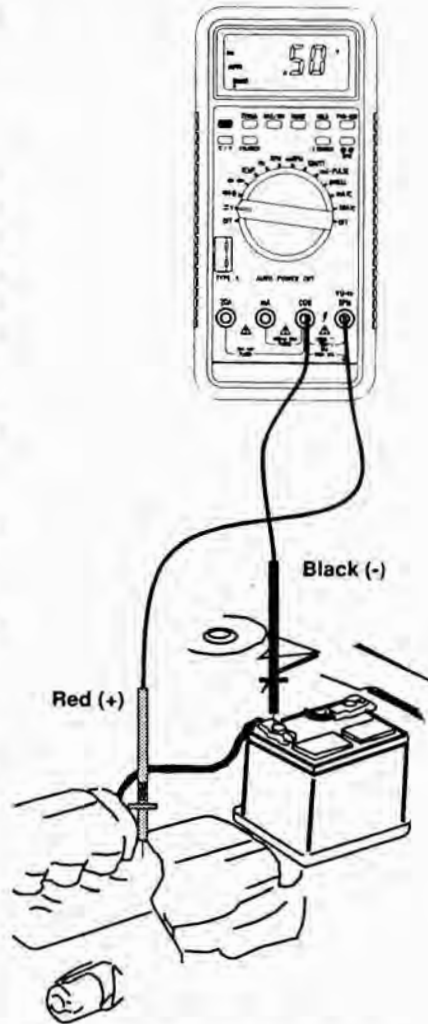

Important: Repeat this test when the engine is thoroughly warmed up. Heat expansion of metal may cause resistance to increase.

Voltage Drop Testing Cont'd...

[2] Negative (-) Chassis Ground

This test checks for chassis ground efficiency.

- Set the rotary switch to Voltage
- Establish the base voltage that you will compare test voltage against (see base voltage, Volt Drop Test [1]).
- Connect the positive (+) lead to the point on the fender, fire wall or vehicle frame where the accessory ground is fastened.
- Connect the (-) lead to the negative (-) battery terminal.
- Set the Min/Max on the meter.
- Turn all of the accessories ON (bright lights, A/C fan - high, rear window defroster, windshield wipers, etc.).
- Disable the ignition so the engine doesn't start; crank the engine for 2-3 seconds.

The example shown has 2 connectors, 1 wire, 1 ground and 1 terminal to battery post. A voltage drop of more than 0.5 volts would indicate a poor ground circuit.

Clean and inspect the battery cable connections and the ground; test again.

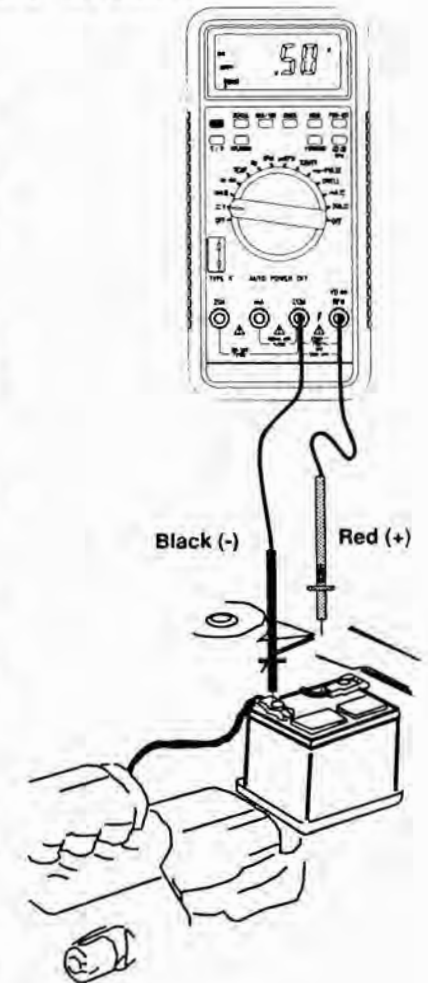

Important: Repeat this test when the engine is thoroughly warmed up. Heat expansion of metal may cause resistance to increase.

Voltage Drop Testing Cont'd...

[3] Battery Power to Starter Solenoid (+)

This test checks battery source efficiency to the starter solenoid.

- Set the rotary switch to Voltage.
- Establish the base voltage that you will compare test voltage against (see base voltage, Volt Drop Test [1])
- Connect the positive (+) lead to the positive (+) battery terminal.
- Connect the negative (-) lead to the positive (+) terminal on the starter solenoid.
- Set the Min/Max feature on the meter.
- Disable the ignition so the engine doesn't start; crank the engine for 2-3 seconds.

The example shown has 2 connectors and 1 wire. A voltage drop of more than 0.3 volts would indicate a poor circuit.

Clean and inspect the battery cables and cable connections; test again.

Important: Repeat this test when the engine is thoroughly warmed up. Heat expansion of metal causes resistance to increase.

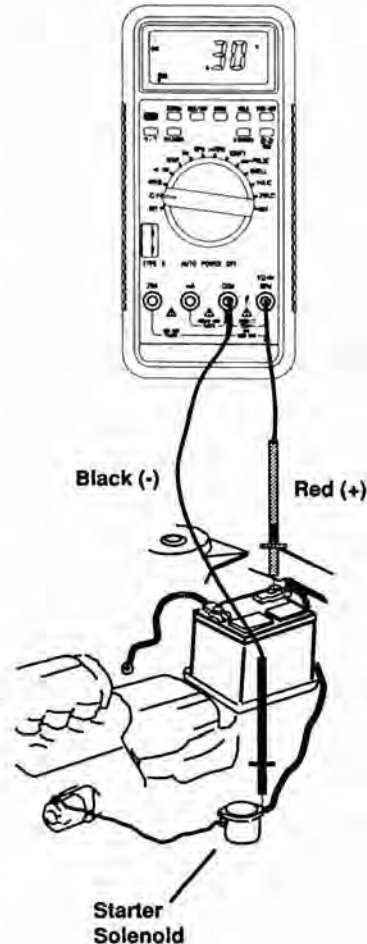

Voltage Drop Testing Cont'd...

[4] Battery Power to Complete Starter Circuit (+)

This test checks battery power efficiency to the starter through the starter solenoid.

- Set the rotary switch to voltage.
- Establish the base voltage that you will compare test voltage against (see base voltage, Volt Drop Test [1]).
- Connect the positive (+) lead to the (+) battery terminal.
- Connect the negative (-) lead to the positive (+) terminal on the starter motor.
- Set the Min/Max on the meter.
- Disable the ignition so the engine doesn't start; crank the engine for 2-3 seconds.

The example shown has 4 connectors, 2 wires and 2 solenoid connections. A voltage drop of more than 0.8 volts would indicate a poor circuit.

Clean and inspect the battery and starter cables, solenoid and cable connections; test again.

Note:

A defective starter solenoid may cause an excessive voltage drop; check the cables and connections before replacing the solenoid.

Important: Repeat this test when the engine is thoroughly warmed up. Heat expansion of metal causes resistance to increase.

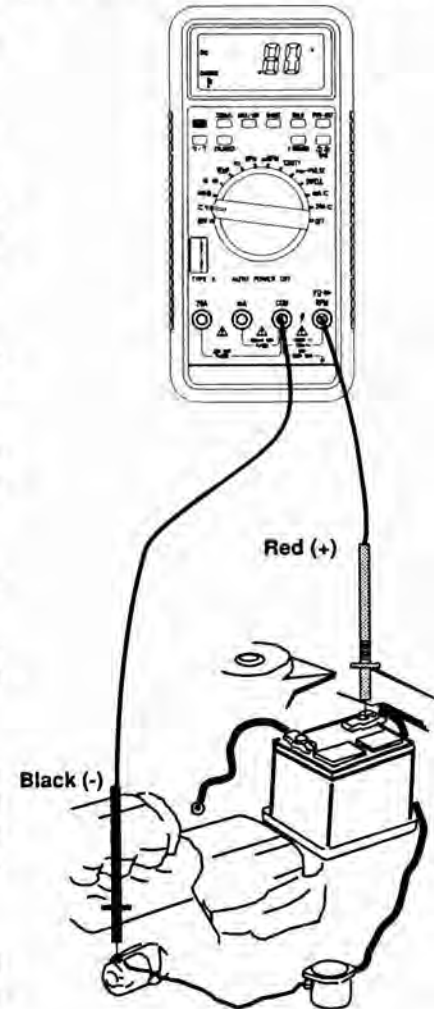

Starter Motor Testing

[1] Starter - Current

The Battery tests and the Voltage Drop tests have verified that there is adequate battery voltage at the starter. Next, check for excessive starter motor current draw.

- Connect a Current Clamp around the negative (-) or positive (+) battery cable.
- Set the rotary switch to the 400 mV setting.
Note: 1mV = 1Amp.
- Set the Min/Max feature on the meter. The Min reading will be the negative current draw.
- Disable the ignition so the engine doesn't start; crank the engine for 2-3 seconds.

Note:

The current clamp measures amps in the direction of electrical flow. Make sure the arrow on the clamp is pointed in the direction of the current flow in the cable.

Quick Test,

Turn the ignition and all accessories OFF. Place the clamp on the battery cable, then turn the headlights on. If the reading is not negative, disconnect the clamp, turn it over and reconnect.

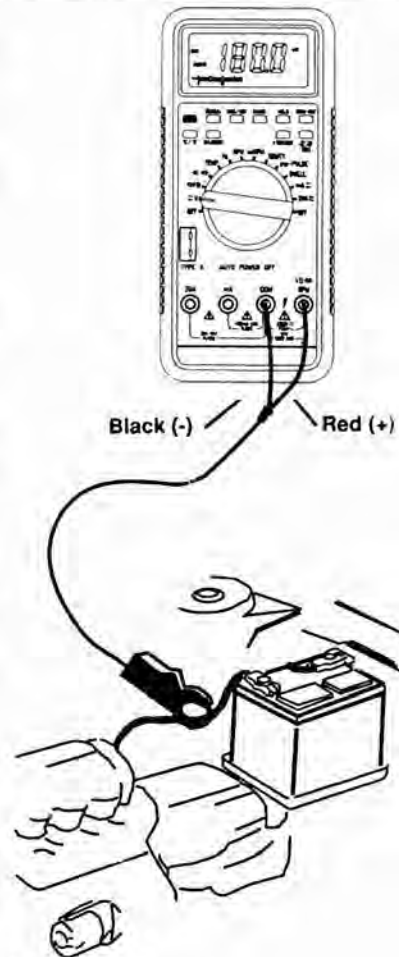

Approximate Amperage Draw

4 Cyl.	150-180 Amp. Maximum
6-8 Cyl., under 300 CID	180-210 Amp. Maximum
6-8 Cyl., over 300 CID	250 Amp. Maximum

Charging System Tests

[1] Battery (+)

This test checks for alternator output voltage at the battery.

- Set the rotary switch to Voltage
- Connect the positive (+) lead to the positive (+) battery terminal.
- Connect the negative (-) lead to the negative (-) battery terminal.
- Set the Min/Max feature on the meter.
- Make sure all vehicle accessories are turned OFF.
- Start the engine and hold at 1500 RPM.

A reading of 13.1-15.5 volts is an acceptable charging rate. If the voltage is low check for:

- Loose, cracked, or glazed drive belt
- Loose or faulty wires or connectors
- Defective alternator or regulator. See [2] Alternator Voltage Output (+), Loaded.

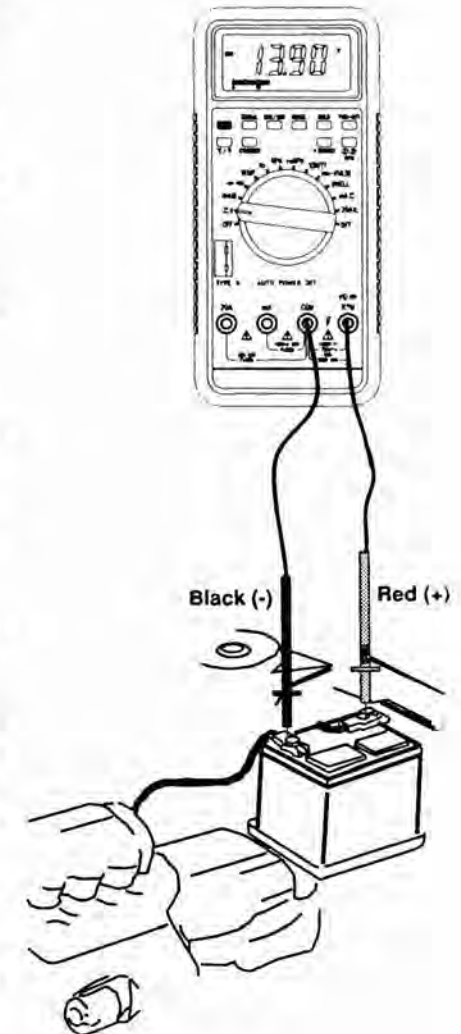

Charging System Tests Cont'd...

[2] Alternator Voltage Output (+), Loaded

This test checks for alternator output voltage. This test is necessary only if the vehicle failed [1] Battery (+) test.

- Set the rotary switch to the **Voltage** setting.
- Connect the positive (+) lead to the battery (B+) output post on the back of the alternator.
- Connect the negative (-) lead to the negative (-) battery terminal.
- Set the Min/Max feature on the meter.
- Start the engine and hold at 1500 RPM.

A reading of 13.1-15.5 volts is an acceptable charging rate.

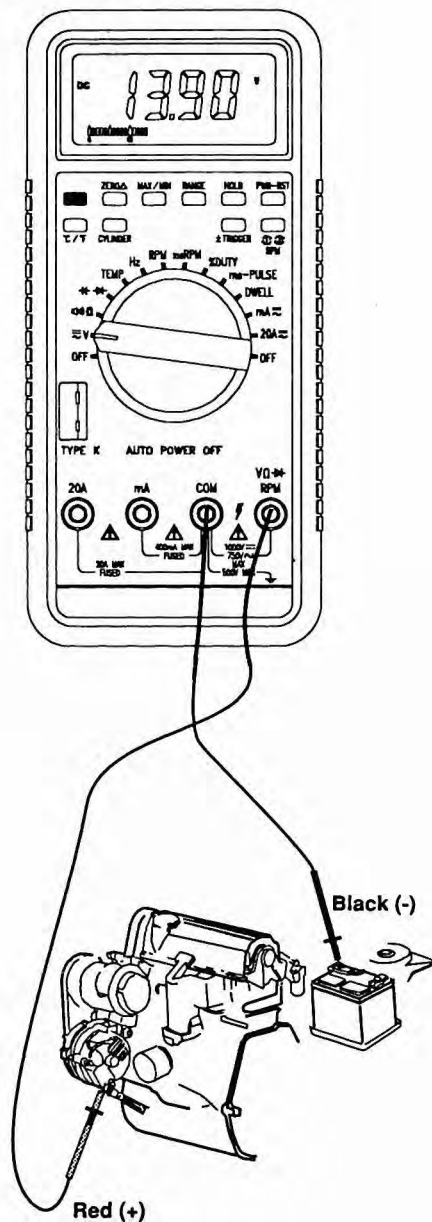

Charging System Tests Cont'd...

[3] Alternator Amperage (A) Output, Battery

This test checks for alternator charging rate efficiency at the battery.

- Connect Current Clamp leads to the meter.
- Connect the Current Clamp around the negative (-) or positive (+) battery cable.
- Set the rotary switch to the **Voltage** setting.
Note: 1mV = 1 Ampere
- Make sure all vehicle accessories are turned OFF.
- Start the engine and hold at 1500 RPM.

The amperage reading should be 5 amps or better.

Note:
The current clamp measures amps in the direction of electrical flow. Make sure the arrow on the clamp is pointed in the direction of the current flow in the cable.

Quick Test,
Place the clamp on the battery cable, then turn the headlights on. If the reading is not negative, disconnect the clamp, turn it over and reconnect.

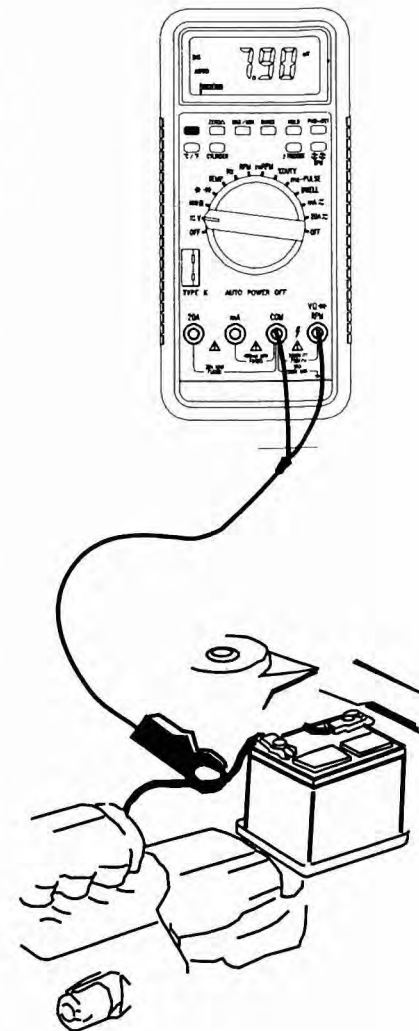

Ignition System Tests

[1] Ignition Coil, Primary Resistance Test (Ω)

This test checks primary winding resistance.

Important: Test the ignition coil cold and hot.

- Set the rotary switch to the Resistance (Ω) setting.

Insert:

- Black lead in COM terminal
- Red lead in V/ Ω /RPM terminal
- Disconnect the coil from the vehicle wiring harness.

• Note: The resistance in the meter leads must be subtracted to get an accurate measurement at the .50-2.0 range. Short the leads together and press the ZERO Δ Button. The meter will automatically subtract the resistance in the leads.

- Connect the negative (-) lead to the negative (-) terminal on the coil.

- Connect the positive (+) lead to the positive (B+) terminal on the coil.

Typical measurements are between 0.50-2.0 Ω 's. Consult the manufacturer's specifications for required resistance measurements.

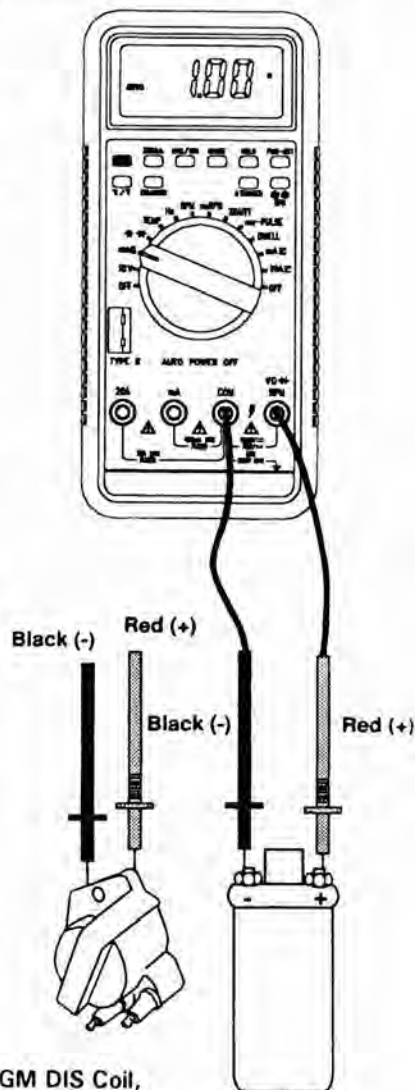

GM DIS Coil,
Type II - Both
primaries
located on back of coil.

Ignition System Tests Cont'd...

[2] Ignition Coil, Secondary Resistance Test (Ω)

This test checks secondary winding resistance.

Important: Test the ignition coil cold and hot.

Set the rotary switch to the Resistance (Ω) setting.

Insert:

- Black lead in COM terminal
- Red lead in V/ Ω /RPM terminal
- Disconnect the coil from the vehicle wiring harness.

- Connect the negative (-) lead to the high tension terminal on the coil.

- Connect the positive (+) lead to the positive (B+) terminal on the coil.

Typical measurements are between 6,000-30,000 Ω 's. Consult the manufacturer's specifications for required resistance measurements.

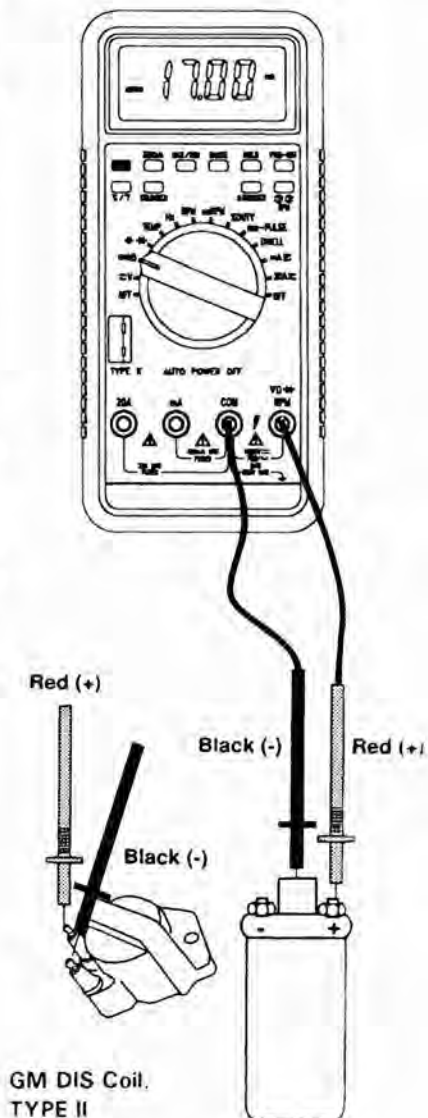

GM DIS Coil,
TYPE II

Basic Diagnostic Testing

Ignition System Tests Cont'd...

[3] Secondary Ignition Wire Resistance Test (Ω)

This test checks for open circuits or high resistance in the secondary (sparkplug) wires.

Important: Twist and bend the sparkplug wire while measuring the resistance for this test.

- Set the rotary switch to the Resistance (Ω).

Insert:

- Black lead in COM terminal.
- Red lead in V/ Ω /RPM terminal.
- Connect the test probes to opposite ends of the sparkplug wire.
- Set the Min/Max feature on the meter.

Typical measurements are approximately 1,000 Ω 's per inch of wire. For example, 10 inch cable = 10,000 Ω .

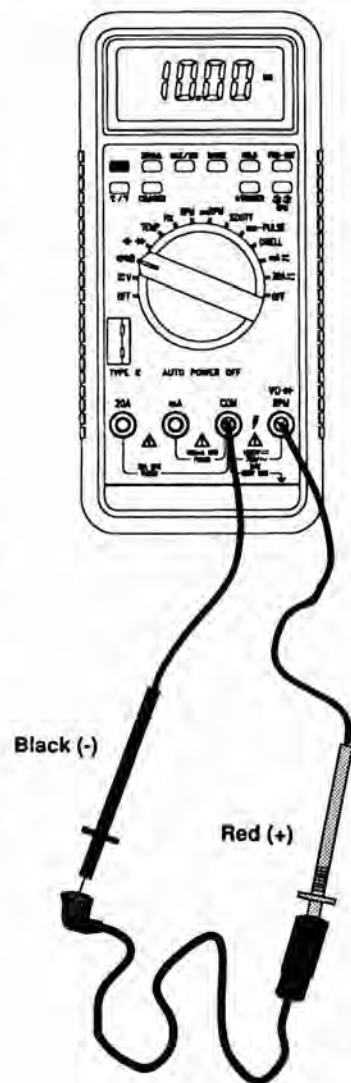

Basic Diagnostic Testing

Ignition System Tests Cont'd...

[4] Distributor Cap/Rotor Resistance Test (Ω)

This test checks for open circuits or high resistance in the distributor cap and rotor.

- Set the rotary switch to the Resistance (Ω).

Insert:

- Black lead in COM terminal.
- Red lead in V/ Ω /RPM terminal.

Dist. Cap Center Connector Test: Connect the test probes to opposite ends of the distributor cap terminal (see illustration).

In general, resistance(Ω) should be 5K-10K. Refer to the Manufacturer's specifications.

Rotor Test:

Connect the test probes to opposite ends of the rotor contacts (see illustration).

In general, resistance should be 0.1 Ω or less. Refer to the Manufacturer's specifications.

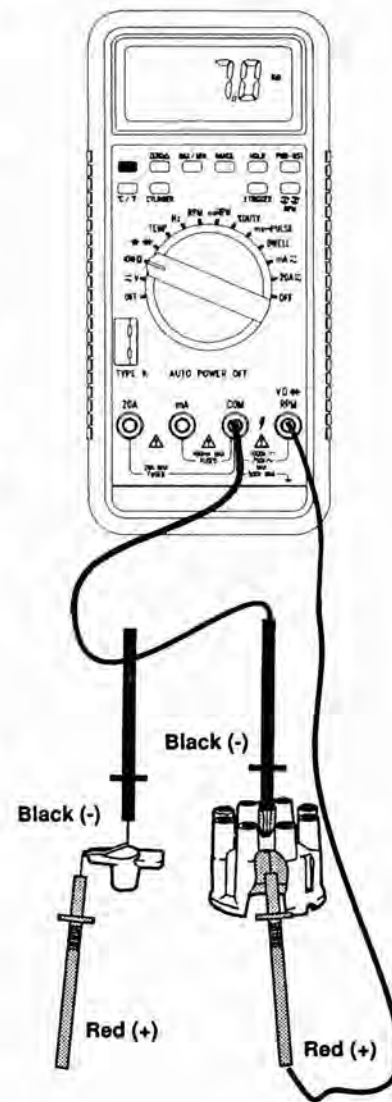

Ignition System Tests Cont'd...

[5] Pick-up Coil Resistance (Ω)/Voltage Test (V)

- The **Resistance** test checks for open circuits or high resistance.
- The **Voltage** test compares voltage output to resistance.

Test Procedure

- Set the rotary switch to the **Resistance (Ω)**.

Insert:

- Black lead in **COM** terminal.
- Red lead in **V/ Ω /RPM** terminal.
- Connect the test probes to the pick-up coil leads (see illus.).

Resistance Specifications

The majority of the pick-up coils will test between 500-1500 Ω 's resistance. See manufacturer's specification for required range.

- Set rotary switch to **Volts**. Press the Blue, Alternate Function button to select **AC**.
- Crank engine 10-15 seconds at normal speed; measure voltage.

Resistance Test/Voltage Output
Resistance (Ω) on a "good" pick-up coil will match AC output voltage (Ex., 950 Ω 's = 950mV output). Resistance can be good but voltage low if the magnet has lost magnetism or if the reluctor is too far from the stator (Air gap).

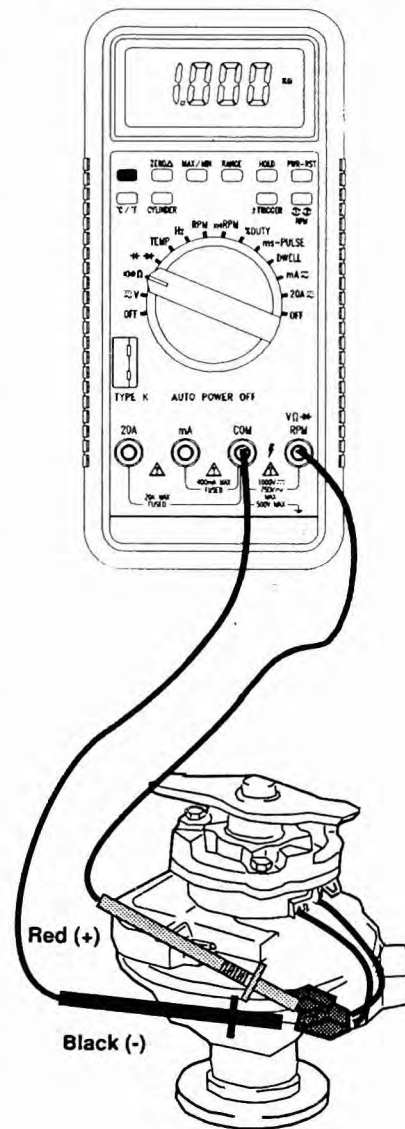

Ignition System Tests Cont'd...

[6] Hall Effect Sensor Voltage Test (V)

This test checks for switching action in any Hall Effect sensor (Ignition, RPM, Crankshaft, etc.)

- Set the rotary switch to the **Voltage (V)** position.

Insert:

- Black Lead in **COM** terminal.
- Red Lead in **V/ Ω /RPM** terminal.
- Set the Min/Max feature on the meter.

- Connect the Black (-) test probe to the negative (-) post on the battery.

- Turn the ignition key ON. Touch the Red (+) test probe to the three test point shown.

- Ground reading should be the same voltage as the ground (Computer or battery).

- Supply line reading should be the same voltage as the input source (Computer or battery).

- Signal Line reading should be 0 or the same voltage as the input source (Computer or battery). The reading will toggle high and low as the shutter rotates.

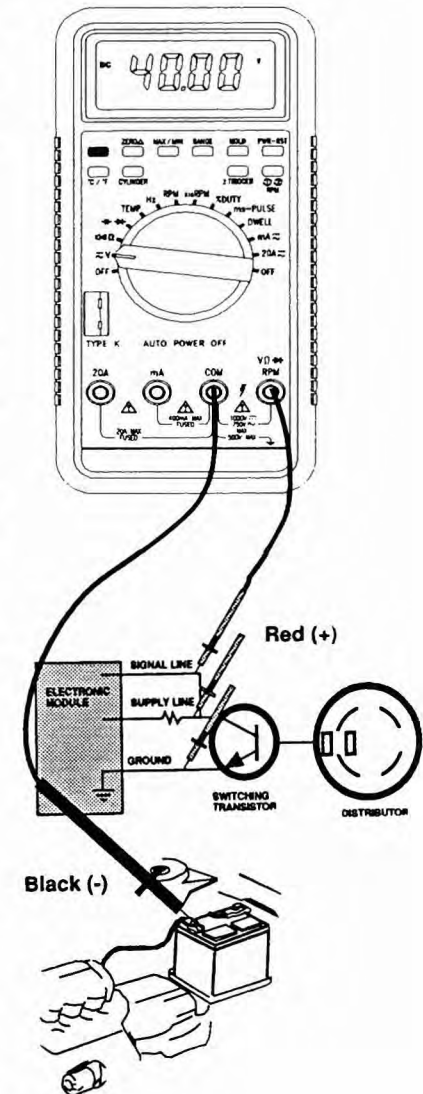

This chapter describes a computer controlled sensor and actuator system typically found on today's automobile.

Test procedures are also provided for the basic groups of electrical input and output components commonly found in a computer controlled automotive system. The test procedures are, due to the complexity of components, general theory tests. Be sure to consult the vehicle service manual for component schematics and test specifications.

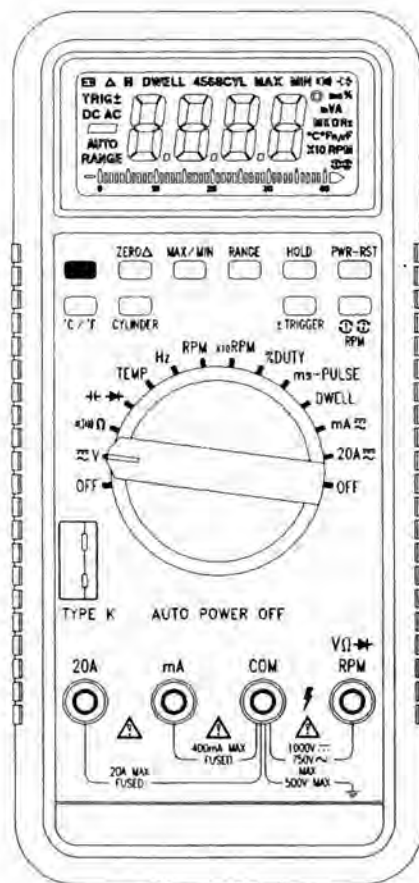

Computer Controlled Systems

A need for better fuel economy and lower emissions resulted in today's automobiles utilizing computer controlled functions that were previously activated by mechanical, electrical and vacuum devices.

Computerized vehicle control systems are made up of three basic component groups. These groups are:

1. **Sensors:** they are input devices that supply information about engine operating conditions and the surrounding environment to the vehicle computer.
2. **Engine Control Module:** a vehicle computer that processes the information supplied by the sensors, then sends an electronic command to the appropriate component actuators.
3. **Actuators:** these are output devices that may be electrical, mechanical or vacuum components controlled by the vehicle computer.

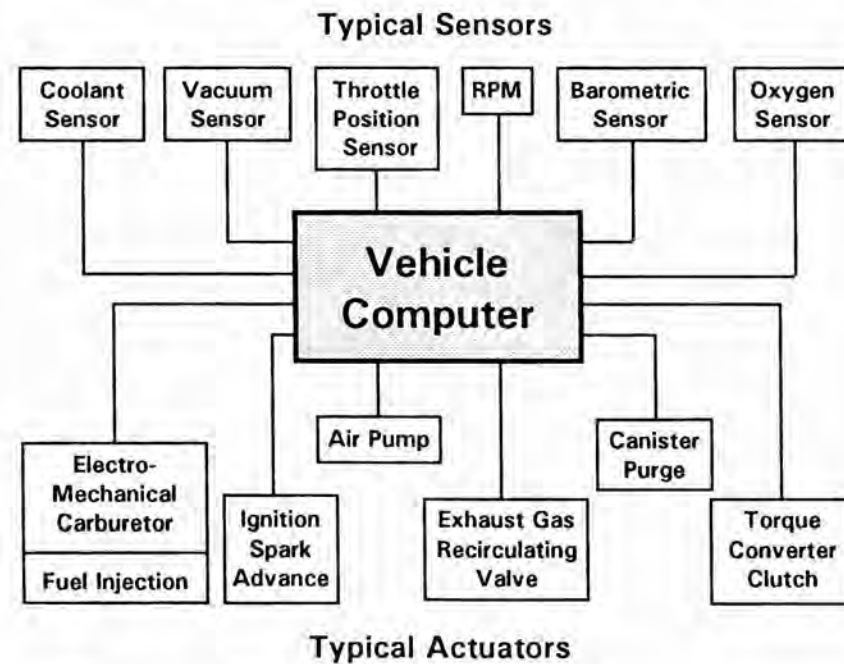

Typical Actuators

Basic Daignostics for the Computer Controlled Engine

There are two important steps that must always be followed when diagnosing and repairing vehicles with computer controls.

- Do basic engine diagnostics first. Many problems can be traced to lack of routine maintenance on components such as plug wires, filters and spark plugs. Also check for vacuum leaks on any vehicle, new or old. A complete engine diagnosis should precede any electrical system diagnostics.
- Follow the published Diagnostic Charts EXACTLY through every step to make a repair on a computer component.

Self-Daignostic Computer Systems

One of the functions of the vehicle computer is to record fault codes produced when a sensor or actuator fails. These failures are usually displayed as a "Current Code" or as an "History Code". Current Codes are further grouped into "Hard Failures" and "Intermittent Failures". Be aware, however, that some vehicle manufacturers use different terminology and older vehicles do not have all of the groups of codes described.

Current Codes are faults that are active.

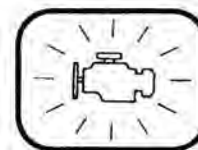

- **Hard Failure** causes the dash "Check Engine" light to remain ON.
- **Intermittent Failure** causes the dash "Check Engine" light to flicker and then go OFF after a short period of time. Generally the trouble code stays in the computer memory.

History Codes are stored codes for faults that have occurred in the past.

Failure Codes

When a failure is detected by the computer, it stores the information in the form of "Fault Codes" (also known as Trouble Codes or Service Codes). These Fault Codes are usually a two or three digit number that identifies the electrical circuit effected. Once these codes have been read the vehicle repair can be started. Be sure to closely follow the vehicle service manual diagnostic procedures, repairs and specifications.

#	DESCRIPTION
13.....	O2 SENSOR CIRCUIT
14.....	COOLANT TEMP HI
15.....	COOLANT SENS LO TMP
21.....	TPS VOLTAGE HI
22.....	TPS VOLTAGE LOW
23.....	MANIFOLD AIR TEMP HI
24.....	VSS LOW
25.....	MANIFOLD AIR TEMP LO
32.....	EGR VACUUM ERROR
33.....	MAP ERROR
34.....	MAP SENSOR HIGH
41.....	CYLINDER SELECT ERROR
42.....	EST GROUNDED
44.....	OS SENSOR LEAN
45.....	O2 SENSOR RIGH
51.....	PROM ERROR

Note: Typical codes are shown as examples only.

Basic Component Testing

Computer Controlled Systems Cont'd...

Component Testing

Component testing with a meter generally requires detailed schematics and specifications that are provided by the manufacturer. The following section provides general information for the main groups of sensors (input) devices and actuators (output) devices.

The primary input devices (sensors) are:

- Temperature sensors
- 2-wire devices
- 3-wire devices
- Oxygen sensor
- Pressure sensors

Primary output devices (actuators) are a form of an electromagnet that is either ON or OFF. The ON/OFF signal, in general, will be in one of three configurations:

- ON or OFF only (switch)
- Pulse width in a specified length of time (fuel injector)
- Duty cycle measured in percent of high or low time or dwell degrees (mixture control solenoid)

Basic Component Testing

Computer Controlled Systems Cont'd...

Duty Cycle, What is it?

Duty Cycle is the **percentage (%) of time a voltage is positive compared to negative: ON compared to OFF**. For example; duty cycle measurements are used for Mixture Control solenoids. The amount of ON time is measured as a percent of the total ON/OFF cycle. The meter can read the negative (-) or positive (+) slope and display it as a percent (%) of the total cycle.

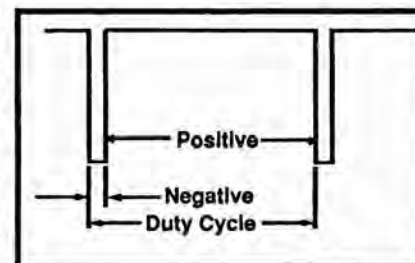

Frequency (Hz), What is it?

Frequency is the **number of times a voltage pattern repeats positive compared to negative: ON compared to OFF, during one (1) second of time**. For example; frequency (Hz) measurements are specified for digitally controlled Manifold Absolute Pressure sensors. The frequency of the ON/OFF signals per second are measured and displayed.

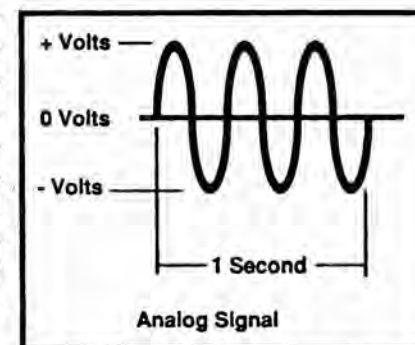

Frequency (Hz) is shown as **Analog**: A continuous positive to negative cycle; or **Digital**: A positive to negative/ON to OFF cycle.

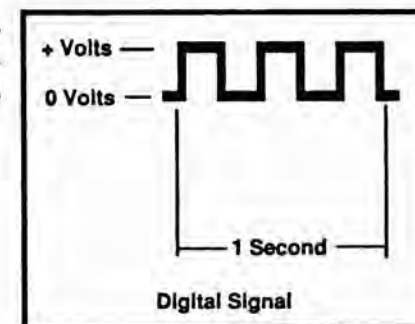

Computer Controlled Systems Cont'd...

Pulse Width, What is it?

Pulse width is the length of time an actuator is energized. For example; fuel injectors are activated by an electronic pulse from the Engine Control Module. This pulse generates a magnetic field that pulls the injector nozzle valve open. The pulse ends and the injector nozzle is closed. This "open to close" time is the pulse width and is measured in milliseconds (mS).

Typical Port Fuel Injectors (PFI) operate with a single ON to OFF electrical pulse.

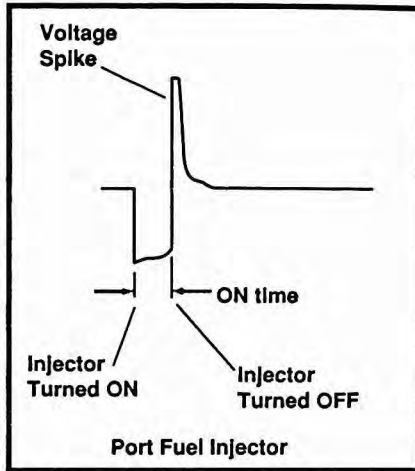

Typical Throttle Body Injectors (TBI) operate with an ON to HOLD to OFF electrical pulse. This method creates a double electrical "spike". An oscilloscope is required to measure this type of pulse.

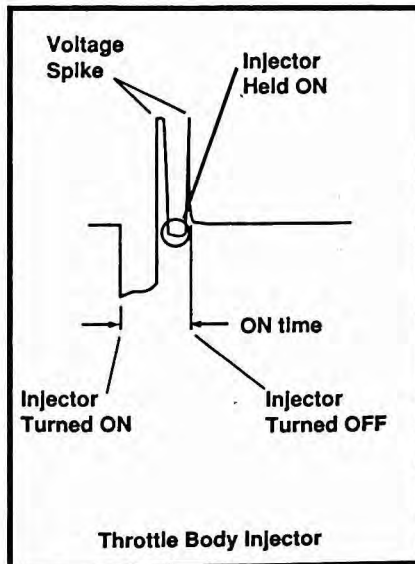

Component Tests (Input)

[1] Temperature Tests

Many components that regulate temperature can be tested by measuring the surface temperature of the area surrounding the component.

- Connect the temperature probe to the meter.
- Set the rotary switch to the Temperature position.
- Set the Min/Max feature on the meter.
- Touch the end of the temperature probe directly to the surface of the component to be tested.

Compare your readings with the manufacturers specifications. The temperature should be within $\pm 10^{\circ}\text{F}$ ($\pm 5^{\circ}\text{C}$) of the data stream values.

Some of the components that can be tested for temperature variation are:

- Radiators
- Transmission
- Heaters
- A/C Condensers
- A/C Evaporators
- Engine Coolant Sensors
- Coolant Temperature Switches
- Air Temperature Sensors

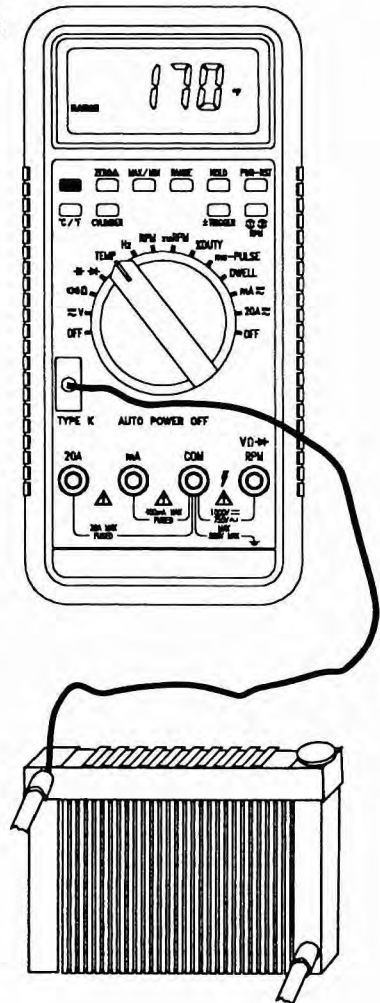

Basic Component Testing

Component Tests (Input) Cont'd...

[2] Thermistor (Variable Resistance, 2-wire) Tests

Thermistors are variable resistors that are sensitive to temperature level changes. As the temperature changes, the thermistor's resistance value changes.

- Select the Ohms (Ω) range with the rotary switch.
- Connect the test probes to the sensor terminals.

The Ohms reading should match the temperature of the sensor (see manufacturer's specifications).

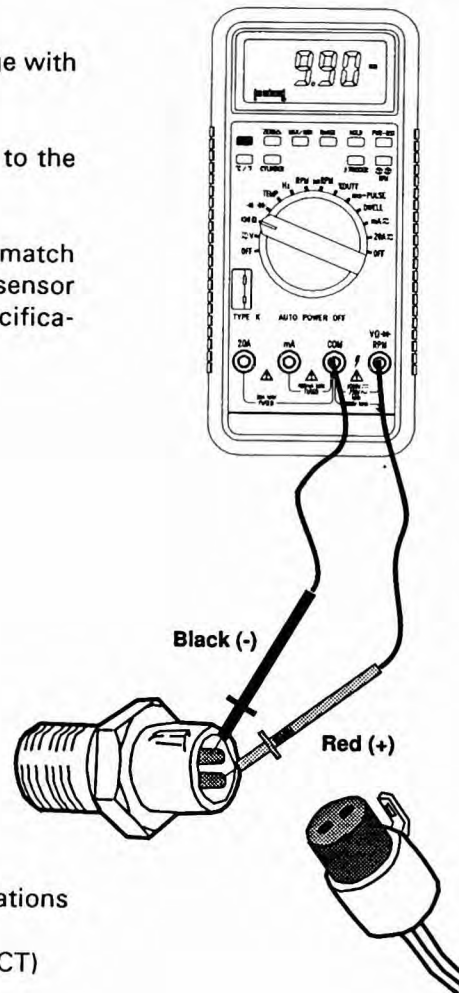

Typical thermistor applications are:

- Engine Coolant Temp. (ECT)
- Air Charge Temp. (ACT)
- Manifold Air Temp. (MAT)
- Vane Air Temp. (VAT)
- Throttle Body Temp. (TBT)

Basic Component Testing

Component Tests (Input) Cont'd...

Thermistor (Variable Resistance, 2-wire) Tests Con't...

Voltage Presence

- Disconnect the vehicle wiring harness at the sensor.
- Select the Voltage range with the rotary switch.

Insert:

- Black lead in COM terminal.
- Red lead in V/ Ω /RPM terminal.
- Connect the test probes in parallel: Positive (+) to the circuit coming from the power source, negative (-) to the negative circuit from the sensor.
- Turn the ignition switch ON; do not start the engine.

Measurement should be 5 - 9 volts (check the manufacturer's specifications).

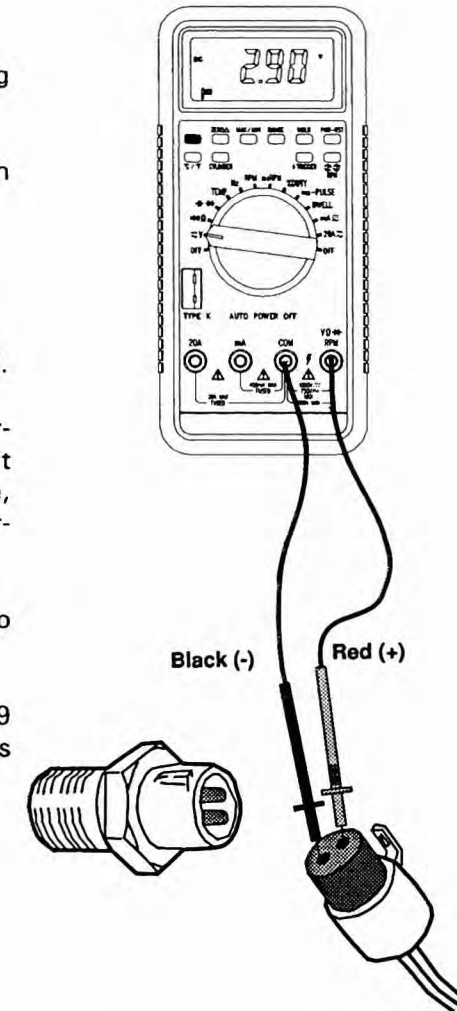

Basic Component Testing

Component Tests (Input) Cont'd...

Thermistor (Variable Resistance, 2-wire) Tests Con't...

Voltage Change

Connect jumper wires between the connector and the sensor.

- Connect the test probes in parallel: Positive (+) to the circuit coming from the power source, negative (-) to the negative circuit from the sensor.
- Start the engine.
- Set the Min/Max feature on the meter.

The voltage should change as the temperature changes. This is the signal that is sent to the computer for processing.

Refer to the manufacturer's specifications. If the voltage change is not within specifications, look for sources of resistance due to poor connectors, connections or breaks in the wiring.

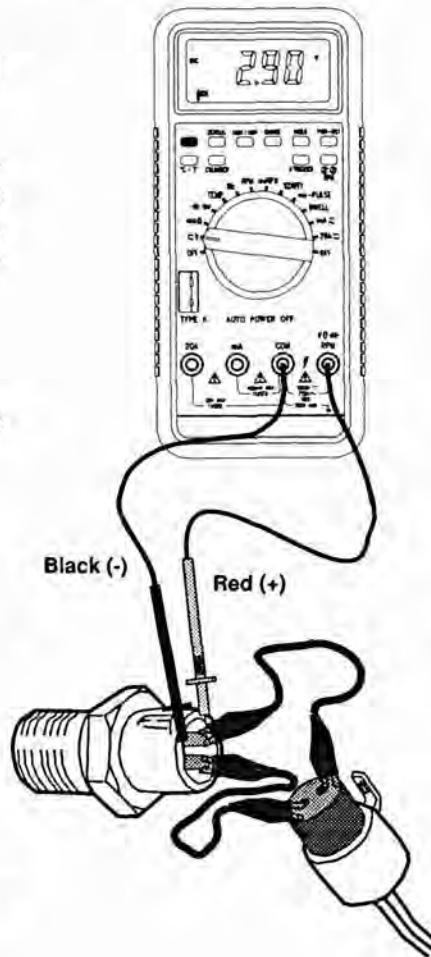

Basic Component Testing

Component Tests (Input) Cont'd...

[3] Potentiometers (Variable Resistance, 3-wire) Tests

The potentiometer is a variable resistor. The signal it generates is used by the vehicle computer to determine position and direction of movement of a device within the component.

Resistance

- Select the Ohms (Ω) range with the rotary switch.
- Disconnect the sensor.
- Connect the test probes to the Signal Line and to the Ground (refer to manufacturer's schematic).
- Set the Min/Max feature on the meter.

Watch the bar graph display; the Ohms reading should change as the signal arm on the potentiometer is moved (signal sweep).

Typical potentiometer applications are:

- Throttle position Sensor (TPS)
- Exhaust Gas Recirculation valve position sensor (EVP)
- Vane Air Flow Meter (VAF)

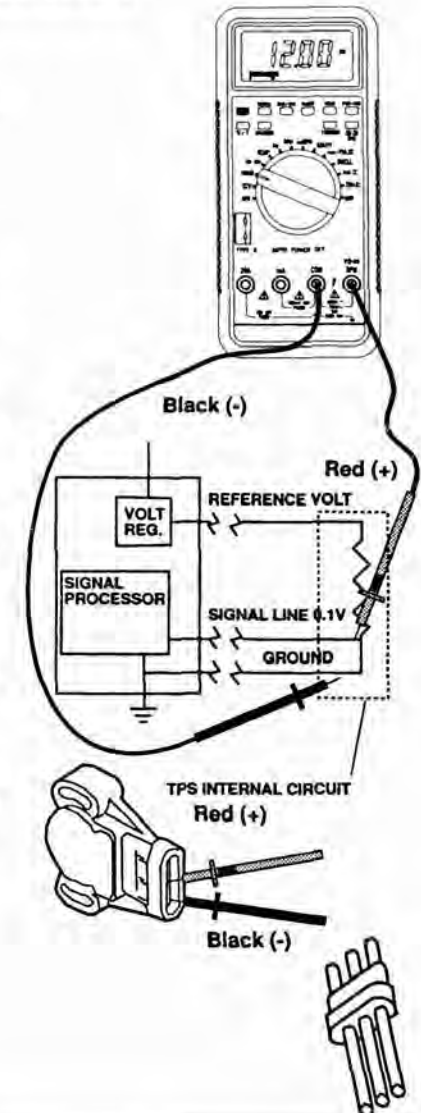

Basic Component Testing

Component Tests (Input) Cont'd...

Potentiometers (Variable Resistance, 3-wire) Tests

Reference Voltage Test

- Disconnect the vehicle wiring harness at the sensor.

- Select the **Voltage** range with the rotary switch.

Insert:

- Black lead in **COM** terminal.
- Red lead in **V/Ω/RPM** terminal.
- Connect the test probes in parallel: Positive (+) to the computer reference voltage circuit, negative (-) to the negative system ground circuit from the sensor.
- Turn the ignition switch ON; do not start the engine.

Watch the bar graph display. Reading should be 5 - 9 volts (check the manufacturer's specifications).

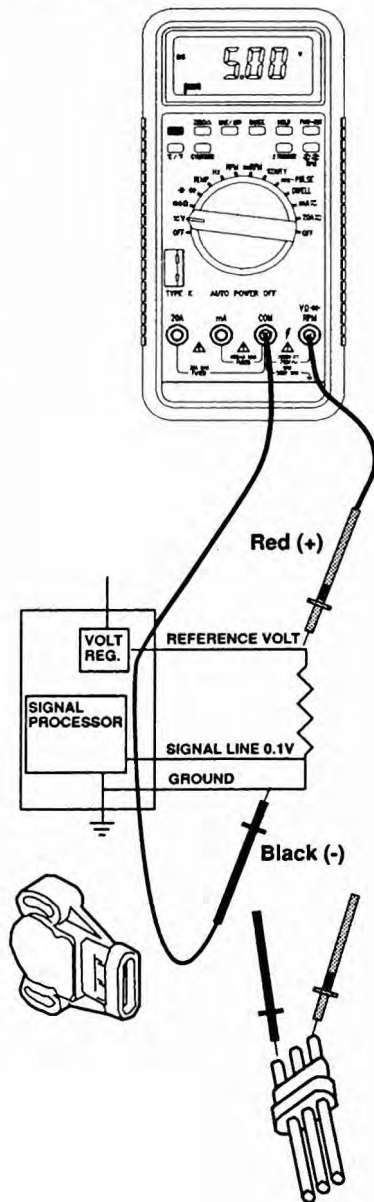

Basic Component Testing

Component Tests (Input) Cont'd...

Potentiometers (Variable Resistance, 3-wire) Tests

Voltage Change

- Connect jumper wires between the connector and the sensor.
- Connect the test probes in parallel: Positive (+) to the signal line, negative (-) to the ground circuit.
- Turn the ignition key ON, do not start the engine.
- Set the Min/Max feature on the meter.

Observe the bar graph display. The voltage drop should change as the position of the signal arm on the potentiometer moves (signal sweep).

Refer to the manufacturer's specifications. If the voltage change is not within specifications, look for sources of resistance due to poor connectors, connections or breaks in the wiring.

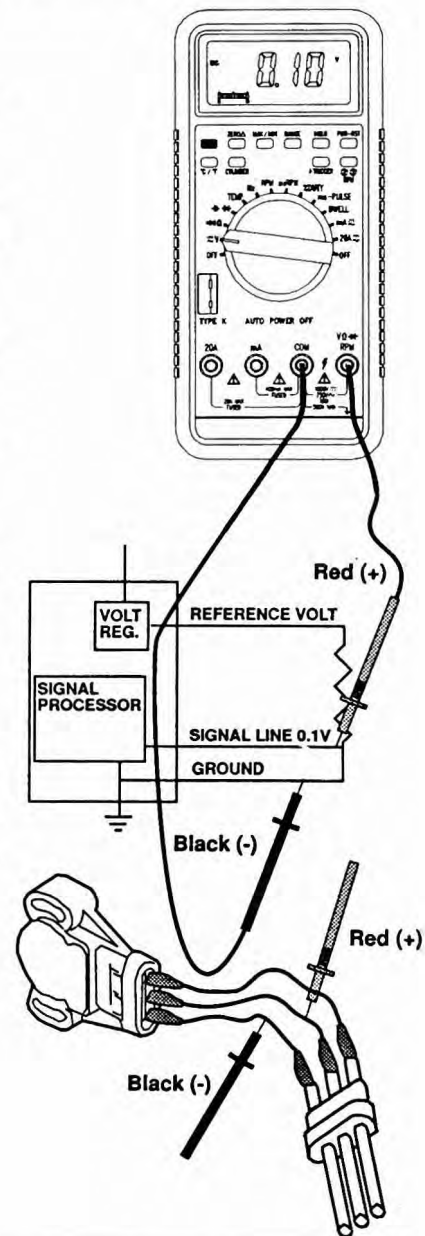

Basic Component Testing

Component Tests (Input) Cont'd...

[4] Oxygen Sensor (O₂) Test

The Oxygen Sensor samples the amount of Oxygen in the exhaust stream. The voltage produced by the O₂ sensor is a direct ratio to the oxygen level in the exhaust stream. This voltage is used by the computer to change the air/fuel mixture.

The test will check oxygen sensor signal output levels.

- Disconnect the vehicle wiring harness at the sensor. Install a jumper wire.
- Select the **Voltage** range with the rotary switch.

Insert:

- Black lead in **COM** terminal.
- Red lead in **V/Ω/RPM** terminal.
- Connect the test probes in parallel: Positive (+) to the jumper wire, negative (-) to the engine ground.
- Set the Min/Max feature on the meter.
- Vehicle engine must be running at operating temperature (fast idle at 2,000 RPM for two minutes).

Voltage readings should move between 0.2 (lean) and 0.8 (rich). The average DC voltage should be around 0.50.

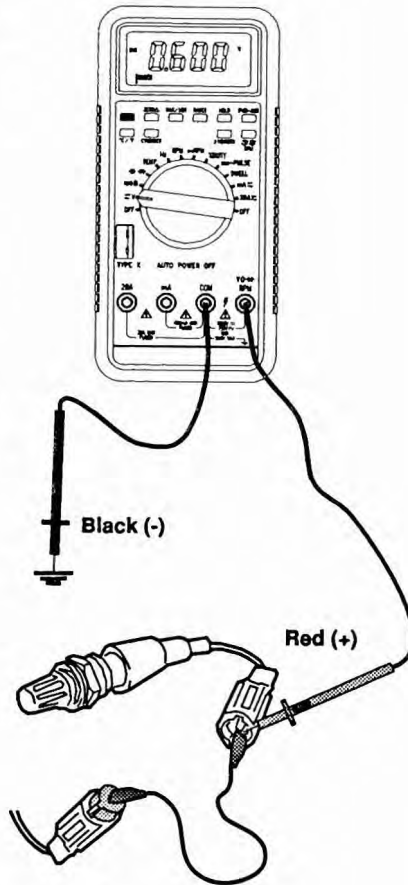

Basic Component Testing

Component Tests (Input) Cont'd...

[5] Pressure sensor Tests

The electrical tests for pressure sensors such as the Manifold Absolute Pressure (MAP) and Barometric Pressure (BARO) vary greatly, depending upon type and manufacturer. Consult the vehicle service manual for the schematic, specifications and test procedures.

General Testing Procedures

Note: You cannot do a resistance (Ω) test for pressure sensors.

Analog Sensor

An analog sensor can be tested with the same series of voltage(V) tests suggested for 3-wire potentiometers. In place of "sweeping" the sensor, use a vacuum pump to vary the pressure on the sensor.

Digital Sensor

Set the meter rotary switch to the Hz setting and perform the same series of tests suggested for 3-wire potentiometer voltage tests. In place of "sweeping" the sensor, a vacuum pump is generally used to vary the pressure on the sensor. In all cases, refer to a vehicle service manual for the correct procedure.

Component Tests (Output)

Output Devices

The electrical tests for output devices vary greatly, depending upon type and manufacturer. Consult the vehicle service manual for the schematic, specifications and test procedures.

Primary output devices (actuators) are a form of an electromagnet that is either ON or OFF. The ON/OFF signal, in general, will be in one of three configurations:

- **ON or OFF only (switch)** Check for continuity with the switch in the ON and OFF position.

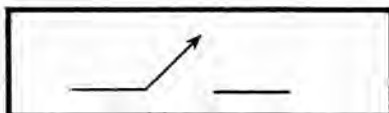

Switch

- **Pulse Width (fuel injector)** Measure the ON time (pulse).

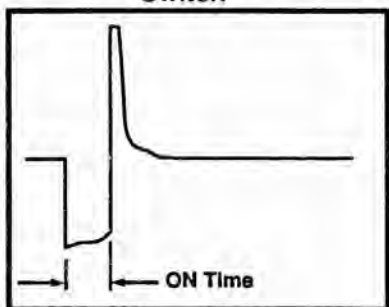

Port Fuel Injector

- **Duty Cycle (Mixture Control Solenoid)** Measure the percent of high (+) or low (-) time in a duty cycle. In most cases the low (-) time is the ON time.

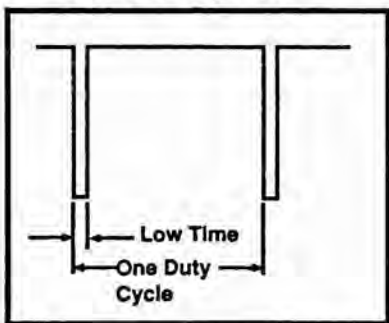

Mixture Control Solenoid

General Specifications

GENERAL SPECIFICATIONS

- **Display:** 3 1/4 digit (4000 counts), 9999 counts (Frequency mode). 40 segments analog bar graph and function units sign annunciators
- **Polarity:** Automatic, (—) negative polarity indication.
- **Overrange Indication:** "4000" Most Significant Digit blinks
- **Low Battery Indication:** The  is displayed when the battery voltage drops below the operating level.
- **Measurement Rate:** 2/sec, nominal. 1/sec, Capacitance and frequency mode. 20/sec, Analog display.
- **Operating Environment:** 0°C to 50°C (32°F to 122°F) at < 70% R.H.
- **Storage Environment:** -20°C to 60°C (-4°F to 140°F) at < 80% R.H.
- **Temperature Coefficient:** 0.1 x (specified accuracy) / °C (< 18°C or > 28°C).
- **Auto Power off:** 30 minutes after rotary switch or mode changes.
- **Power:** Single 9 Volt battery (NEDA 1604 or IEC 6F22).
- **Battery Life:** 200 hours typical with alkaline battery.
- **Fuse:** 20A/600V, 10.3x38mm fast acting ceramic type (100kA rupture). 0.5A/600V, 6.3x25mm fast acting type.
- **Size (HxWxL):** 1.5 in x 3.4 in x 7.5 in (37mm x 87mm x 189mm)
- **Weight:** Approx. 385g (Meter Only), 495g (With Holster)

Electrical Specifications

ELECTRICAL SPECIFICATIONS

*Accuracy is given as \pm (1% of reading) + (number of least significant digits) at 18°C to 28°C (65°F to 83°F), with relative humidity up to 70%.

RPM (Tach)

Ranges: 600-4000, 6000-12000 (x10 RPM)

Resolution: 1 RPM

Effect Reading: > 600 RPM

Accuracy: \pm (2%rdg + 1dgt)

Overload protection: 500 VDC or RMS AC

PULSE WIDTH

Range: 0.1ms - 10.0ms

Accuracy: \pm (2.0%rdg + 0.2ms)

Overload protection: 500 VDC or RMS AC

% DUTY CYCLE

Range: 0.0 - 90.0%

Resolution: 0.1%

Pulse width: > 100 μ s, < 100ms

Accuracy: \pm (2.0% rdg + 5 dgts)

Overload protection: 500 VDC or RMS AC

DWELL ANGLE

No. of cylinders: 4, 5, 6, 8

Ranges: 0 - 90.0° (4 CYL), 0 - 72.0° (5 CYL), 0 - 60.0° (6 CYL),

0 - 45.0° (8 CYL)

Resolution: 0.1°

Accuracy: \pm (2.0% rdg + 5 dgts)

Overload protection: 500 VDC or RMS AC

TEMPERATURE

Ranges: -50 to 1100°C, -50 to 2000°F

Resolution: 1°C/1°F

Accuracy: \pm (1.0% rdg + 2°C)

\pm (1.0% rdg + 4°F)

Sensor: Type K Thermocouple

Input protection: 60VDC or 24VAC rms

Electrical Specifications Cont'd...

DC VOLTAGE (Autoranging)

Ranges: 400mV, 4V, 40V, 400V, 1000V

Resolution: 100 μ V

Accuracy: \pm (0.5% rdg + 1dgt)

Input impedance: > 10M Ω

Overload protection: 1000VDC or 750 VAC rms

AC VOLTAGE (Autoranging)

Ranges: 400mV, 4V, 40V, 400V, 750V (400mV only in Manual)

Resolution: 100 μ V

Accuracy: \pm (1.2% rdg + 3dgts) at 50Hz to 500Hz

\pm (2.0% rdg + 5dgts) at 500Hz to 1KHz

* The Frequency Response for 400mV range are 50Hz to 100Hz only

Input impedance: > 10M Ω

Overload protection: 1000VDC or 750VAC rms

DC CURRENT

Ranges: 400mA, 20A

Resolution: 0.1mA

Accuracy: \pm (1.0% rdg + 1dgt) on 400mA range

\pm (1.5% rdg + 1dgt) on 20A range

Input protection: 0.5A/600V fuse on 400mA range

20A/600V high energy fuse on 20A range

AC CURRENT

Ranges: 400mA, 20A

Resolution: 0.1mA

Frequency response: 50Hz to 500Hz

Accuracy: \pm (1.5% rdg + 3dgts) on 400mA range

\pm (2.0% rdg + 3dgts) on 20A range

Input protection: 0.5A/600V fuse on 400mA range

20A/600V high energy fuse on 20A range

RESISTANCE (Autoranging)

Ranges: 400 Ω , 4K Ω , 40K Ω , 400K Ω , 4M Ω , 40M Ω

Accuracy: \pm (1.2% rdg + 4dgts) on 400 Ω range

\pm (1.0% rdg + 2dgts) on 4K to 400K Ω ranges

\pm (2.0% rdg + 4dgts) on 4M Ω to 40M Ω ranges

Open circuit voltage: 0.4VDC

Overload protection: 500VDC or RMS AC

Specifications

Electrical Specifications Cont'd...

FREQUENCY (Autoranging)

Ranges: 100Hz, 1KHz, 10KHz, 100KHz, 400KHz

Resolution: 0.01Hz

Accuracy: $\pm(0.1\% \text{ rdg} + 4\text{dgts})$ on 1KHz to 100KHz ranges
 $\pm(0.1\% \text{ rdg} + 15\text{dgts})$ on 100Hz or 400KHz ranges

Sensitivity: 400mV

Overload protection: 500VDC or RMS AC

CAPACITANCE (Autoranging)

Ranges: 4nF, 40nF, 400nF, 4 μ F, 40 μ F

Resolution: 1pF

Accuracy: $\pm(2.0\% \text{ rdg} + 20\text{dgts})$ on 4nF range
 $\pm(2.0\% \text{ rdg} + 4\text{dgts})$ on 40nF to 20 μ F ranges
 $\pm(5.0\% \text{ rdg} + 4\text{dgts})$ on 20 μ F to 40 μ F ranges

Overload protection: 500VDC or RMS AC

DIODE TEST

Test current: 0.6mA typical

Resolution: 1mV

Accuracy: $\pm(2.0\% \text{ rdg} + 2\text{dgts})$

Open circuit voltage: 3.0Vdc typical

Overload protection: 500VDC or RMS AC

AUDIBLE CONTINUITY

Open circuit voltage: 0.4Vdc

Audible threshold: Less than 40 Ω

Overload protection: 500VDC or RMS AC

P/N: 7000-1276